

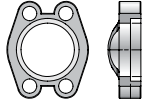

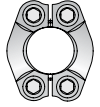







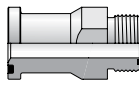
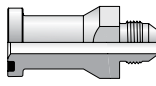
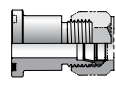
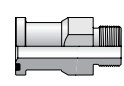
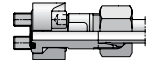
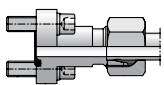

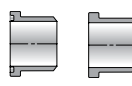
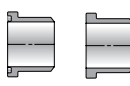
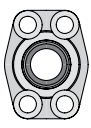
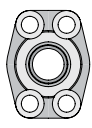
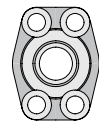
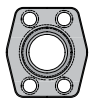
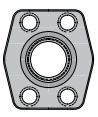
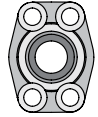
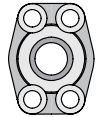
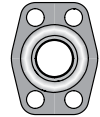
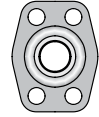
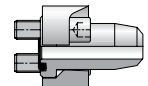
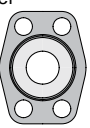
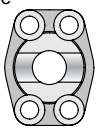
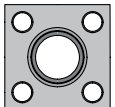
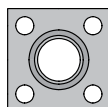
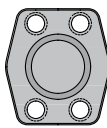
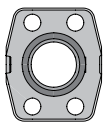
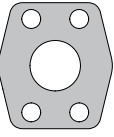
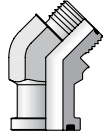
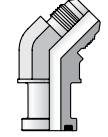
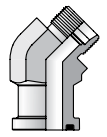
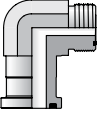
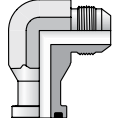
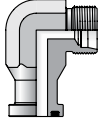
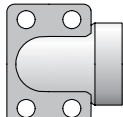
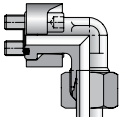
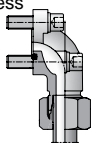
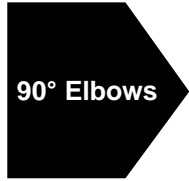
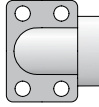
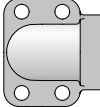
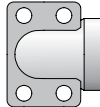
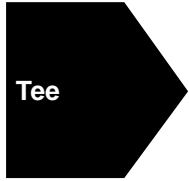
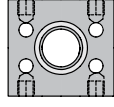

Hydraulic Flanges & Components & Dual Seal Flanges

Hydraulic Flanges and Components

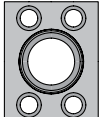
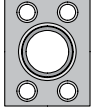
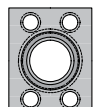
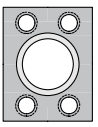





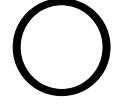



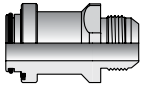

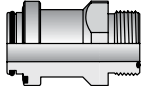
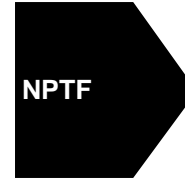
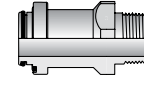
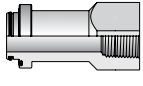
<p>Flange Clamps</p>	<p>FCS Flange Clamps – Split</p>  <p>L9</p>	<p>FCC Flange Clamp – Captive</p>  <p>L9</p>	<p>FHS3 Code 61 Flange Clamps – Metric</p>  <p>L10</p>	<p>FHS6 Code 62 Flange Clamps – Metric</p>  <p>L11</p>	
<p>Straight Flange Adapters / Flanges</p>	<p>LOHQ Code 61, 62 / ORFS</p>  <p>L12</p>	<p>XHQ Code 61, 62 / 37° Flare</p>  <p>L12</p>	<p>BUHQ1 Code 61 / Flareless</p>  <p>L12</p>	<p>F5OHQ Code 61, 62 / SAE-ORB</p>  <p>L13</p>	<p>GFS Code 61, 62 / Metric Flareless</p>  <p>L14</p>
<p>BFG DIN Flange / Metric Flareless</p>  <p>L15</p>	<p>B3HQ Code 61, 62 / Flareless</p>  <p>L13</p>	<p>P Flange Head Plug</p>  <p>L15</p>	<p>W7HQ Flange Head / Pipe Socket</p>  <p>L16</p>	<p>G5HQ Flange Head / SAE-ORB</p>  <p>L16</p>	<p>GHQ Flange Head / NPT</p>  <p>L16</p>
<p>WB1/3/5HQ1 Code 61 / Weld Butt – Pipe</p>  <p>L17</p>	<p>WB3/5/7HQ2 Code 62 / Weld Butt – Pipe</p>  <p>L17</p>	<p>G5Q Code 61, 62 / SAE-ORB</p>  <p>L18</p>	<p>GQ Code 61, 62 / NPT</p>  <p>L18</p>	<p>G4Q Code 61, 62 / BSPP</p>  <p>L19</p>	<p>W5Q Code 61, 62 / Socket – Pipe</p>  <p>L20</p>
<p>W4Q Code 61, 62 / Socket – Tube</p>  <p>L21</p>	<p>W7Q Code 61, 62 / Ext Socket – Pipe</p>  <p>L22</p>	<p>W6Q Code 61, 62 / Ext Socket – Tube</p>  <p>L23</p>	<p>WB1/3/5Q1 Code 61 / Weld Butt – Pipe</p>  <p>L24</p>	<p>WB3/5/7Q2 Code 62 / Weld Butt – Pipe</p>  <p>L25</p>	<p>AS Code 61, 62 / Weld Butt – Tube Metric</p>  <p>L26</p>
<p>WBT Code 61 / Weld Tank Adapter</p>  <p>L26</p>	<p>WSD Code 61, 62 / Weld Saddle</p>  <p>L27</p>	<p>GQS Square Flange / NPT</p>  <p>L27</p>	<p>W5SQS Square Flange / Weld Socket – Pipe</p>  <p>L28</p>	<p>PQ Code 61, 62 / Blank</p>  <p>L28</p>	<p>SPGG5 Flange Spacer w/Gage Ports</p>  <p>L29</p>
<p>CP Flange Connector Plate</p>  <p>L29</p>	<p>45° Flange Adapters</p>	<p>LOVQ Code 61, 62 / ORFS</p>  <p>L30</p>	<p>XVQ Code 61, 62 / 37° Flare</p>  <p>L30</p>	<p>BUVQ1 Code 61 / Flareless</p>  <p>L30</p>	
<p>90° Flange Adapters</p>	<p>LOEQ Code 61, 62 / ORFS</p>  <p>L31</p>	<p>XEQ Code 61, 62 / 37° Flare</p>  <p>L31</p>	<p>BUEQ1 Code 61 / Flareless</p>  <p>L31</p>	<p>W7EQ Code 61, 62 / Weld Socket – Pipe</p>  <p>L32</p>	<p>WFS Code 61, 62 / Metric Flareless</p>  <p>L33</p>

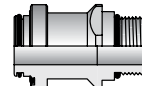
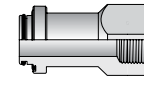
<p>BFW DIN Flange / Metric Flareless</p>  <p>L34</p>	<p>90° Elbows</p> 	<p>G5EQ Code 61, 62 / SAE-ORB</p>  <p>L35</p>	<p>GEQ Code 61, 62 / NPT</p>  <p>L36</p>	<p>W6EQ Code 61, 62 / Weld Socket – Tube</p>  <p>L37</p>	
<p>Tee</p> 	<p>QPQPJQ Code 61, 62 Junction Tee</p>  <p>L35</p>	<p>Stainless Steel Flanges</p> 	<p>G5Q Code 61, 62 / SAE-ORB</p>  <p>L38</p>	<p>GQ Code 61, 62 / NPT</p>  <p>L38</p>	<p>W5Q Code 61, 62 / Weld Socket – Pipe</p>  <p>L39</p>
<p>PQ Code 61, 62 / Blank</p>  <p>L40</p>					

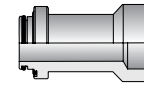
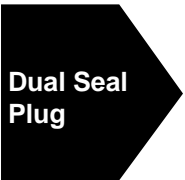
O-Rings and Seals (Shown in Section N)

<p>O-Rings and Seals</p> 	<p>ORFS O-Ring</p>  <p>N4</p>	<p>SAE 4-Bolt Flange O-Ring</p>  <p>N10</p>
--	---	---

Dual Seal Flanges

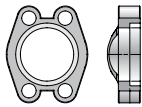
 <p>37° Flare</p>	<p>XHQ40 37° Flare</p>  <p>L41</p>	 <p>ORFS</p>	<p>LOHQ40 ORFS</p>  <p>L41</p>	 <p>NPTF</p>	<p>FHQ40 Male NPTF</p>  <p>L41</p>
<p>GHQ40 Female NPTF</p>  <p>L42</p>	 <p>SAE-ORB</p>	<p>F5OHQ40 Male SAE-ORB</p>  <p>L42</p>	<p>G5HQ40 Female SAE-ORB</p>  <p>L42</p>	 <p>Socket Weld Pipe</p>	<p>W7HQ40 Socket Weld Pipe</p>  <p>L43</p>
 <p>Dual Seal Plug</p>	<p>PQ40 Dual Seal Plug</p>  <p>L43</p>	 <p>Q4 Insert</p>	<p>Q4 Insert Flange Insert</p>  <p>L43</p>		
 <p>Flange Clamps</p>	<p>FCS Flange Clamps – Split</p>  <p>L9</p>	<p>FCC Flange Clamp – Captive</p>  <p>L9</p>			

O-Rings and Seals (Shown in Section N)

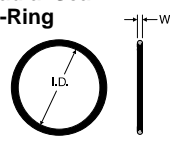
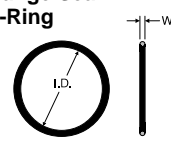
 <p>O-Rings and Seals</p>	<p>Radial Seal O-Ring</p>  <p>I.D. W</p> <p>N10</p>	<p>Flange Seal O-Ring</p>  <p>I.D. W</p> <p>N10</p>
---	--	--

Hydraulic Flanges and Components

The 4-bolt flange connections conforming to SAE J518 and ISO 6162-1 and -2 are proven, leak-free connections, especially suited for larger sizes, higher pressures and assembly in tight quarters. Threaded port connections such as SAE straight thread O-ring and ISO 6149 are reasonably easy to assemble and provide 6000 psi and higher pressure capability up to size 12 (M27). Beyond this size the pressure rating starts to decrease and assembly torques increase rapidly. The 4-bolt flange port connections provide ability to connect larger sizes and achieve higher-pressure capability at reasonable assembly torques. Because of the lower assembly torques compared to an equivalent size threaded port, these connections are well suited for tight quarters where wrench clearances are limited. Parker 4-bolt flange products described in this part of the catalog provide various means of connecting tubes, hoses, pipes and threaded fittings to 4-bolt flange ports. The discussion below provides an overview of some of the available flange products.

Design and Construction

Parker 4-bolt flange products are designed to provide different methods of connecting a tube, hose, pipe or another fitting to the SAE standard 4-bolt flange port.

Flange Fittings — All Parker flange fittings, except for those with square mounting hole patterns (nomenclature code QS), are designed to conform to O-ring groove, bolt holes and bolt pattern dimensions of either Code 61 or Code 62 of SAE J518 and ISO 6162-1 (Code 61) or -2 (Code 62).

The flange adapters (Code Q1 and Q2), and flange block fittings (Codes Q1B, Q2B and QSB) have O-ring grooves conforming to dimensions in SAE J518. The flange block fittings (Codes Q1B and Q2B) have through holes for the mounting bolts, again conforming to SAE J518. There is no industry standard for the bolt pattern of the square pattern block flanges with codes QSP and QSB.

The flange pad fittings (Codes Q1P, Q2P, and QSP) have a flat face (no O-ring groove) and the mounting holes are tapped. Where these fittings are used, the seal is in the mating part (flange adapter, flange hose fitting, flange block fitting, etc.) as shown in Fig. L1.

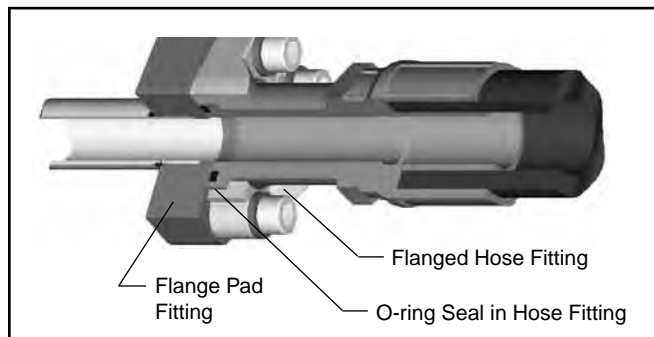

Fig. L1 – Flange Pad Fitting

Dimensions other than the O-ring groove, bolt holes, bolt pattern, and the flange foot print (for codes Q1B and Q2B only) are not governed by any industry standard. However, Parker product design follows common industry practice and sound engineering.

Dimensions and pressures for reference only, subject to change.

Flange Clamps — Clamps are used for providing the holding power to the 4-bolt flange connection. They are offered in split and captive (one-piece) versions. The captive version is also offered with either drilled or tapped bolt holes. The captive flange clamp with tapped holes is used while connecting a tube to another tube or a hose.

Parker flange clamps are forged for higher strength and durability. They meet all requirements of SAE J518. The split clamps make it easy to assemble the connection in close quarters. They also make removal of the flange head component, such as a hose assembly, easy by loosening all four bolts and removing one clamp half, as shown in Fig. L2.

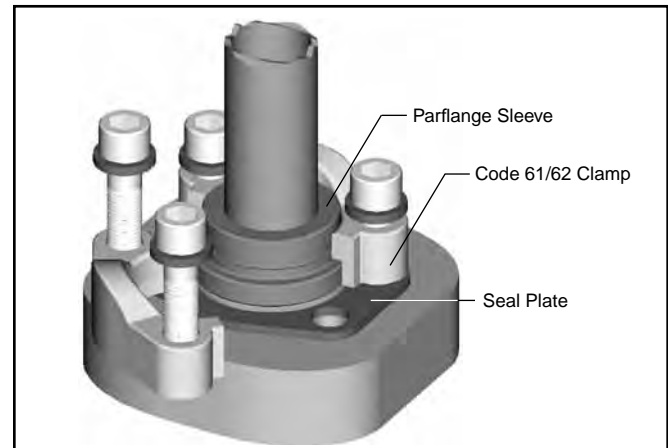

Fig. L2 – Assembly / Removal SAE J518 Connection

Junction Block Tees — These are solid block union fittings to connect two tube/hose assemblies using 4-bolt flange connection, at a junction, to SAE 4-bolt flange port, or three tube/hose assemblies to each other.

Connector Plate — Connector plate is used as a middle plate to connect two flange heads with O-ring grooves, such as two hose assemblies with flange connection ends. The flat surface of the plate provides sealing surface on each side for the O-ring housed in the hose ends.

Spacer Plate — Spacer plate provides access to the system fluid via the gage port on the side. The plate is between the flange connection to provide this access.

Plugs — Plugs provide a means to block off the 4-bolt flange port with and without clamps, and to plug the end of a pipe (via welding).

Tank Weld Adapter — Tank weld adapters provide a means of flange connection to a fabricated reservoir or tank.

Hydraulic Flanges	Steel		Stainless Steel	
	ASTM	Type	ASTM	Type
4-Bolt Flanges	A108	C1020	A240	316L
Flange Clamps	A108	C1045	A351 / A743	Nitronic 50
HHCS Bolts	SAE Grade 8		—	—
SHCS Bolts	—	—	A240	316

Table L1 – Standard Material Specifications for Hydraulic Flanges and Components

Note: Split flange clamps are zinc clear (or Cr6 free) chromate. All other steel flanges are oil dipped. Flange adapters are not plated.

How Flange Connections Work

The four-bolt flange connection (SAE J518) is a proven leak-free connection, especially suited for larger sizes. As a result, it has achieved worldwide acceptance.

The connection's success is in its simplicity. It is a static face seal using a high durometer O-ring for the seal and clamps and bolts for holding power as shown in Fig. L3. Alternatively, a bonded seal plate is between the port face and the flat face of a mechanically formed (flanged with Parflange® process) tube as shown in Fig. L4 to achieve the same results.

The (O-ring) seal is compressed between the bottom of the groove in the flange head and the flat surface of the port or flange pad, providing a reliable soft seal. The alternate seal plate has a high durometer bonded rubber seal on the inside edge, which compresses between the two flat surfaces, providing a soft seal with the same reliability. A metal-to-metal contact at the outer face of the flange with the port face keeps the seal from extruding under pressure. This metal-to-metal contact is maintained by the clamping force provided by tightening the bolts via the clamps.

This simple design provides several advantages over threaded port connections, such as NPTF, SAE, BSPP, ISO 6149, etc., in larger sizes:

- Ability to connect up to 5 inch O.D tube (Code 61 only)
- Much lower tightening torque required from the four bolts compared to that required for equivalent size threaded port
- Less tightening torque means smaller wrenches and wrench swing clearances — providing ease of assembly in tight quarters
- Up to 6000 psi capability through 2" size (Code 62 only)
- Single seal point between tube/pipe/hose assembly and the port
- Ease of disassembly through use of split clamps

The connection has one disadvantage — it requires a larger area (foot print) on the component than an equivalent threaded port.

Assembly and Installation

Please refer to Section S for the assembly and installation instructions for Hydraulic Flanges and Components fittings.

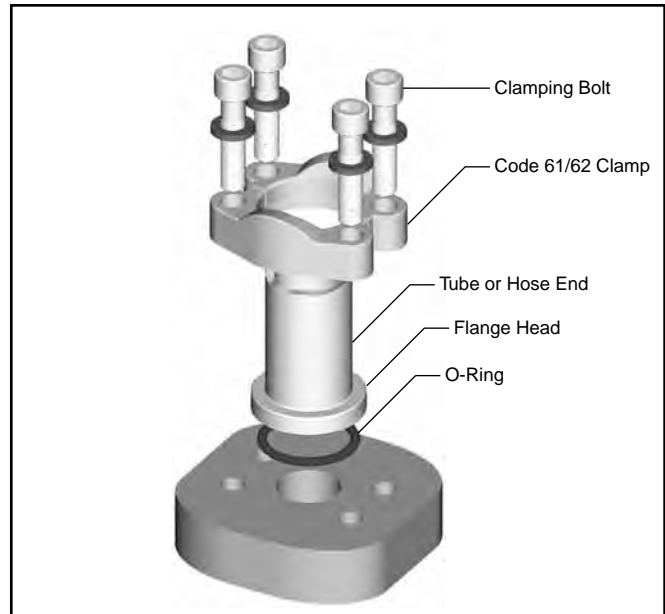

Fig. L3 – Four-Bolt Flange Connection (SAE J518)

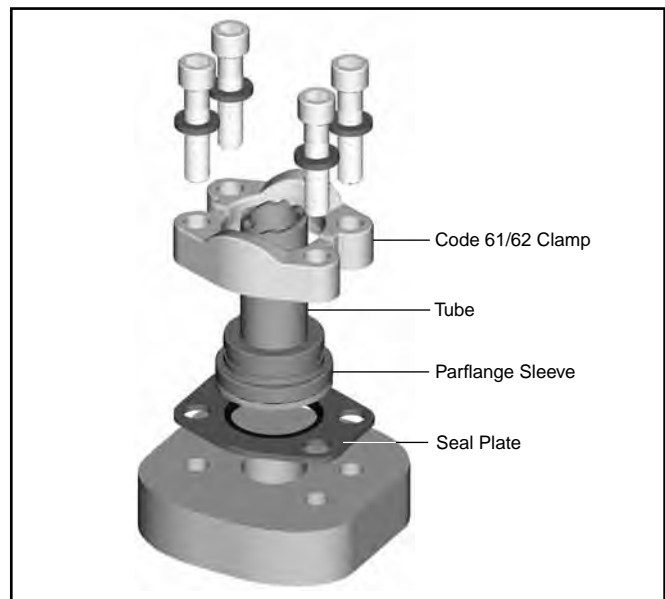

Fig. L4 – Formed Tube with ISO 6162 (SAE J518) Connection

Feature	Advantage	Benefit
Conform to SAE J518 and ISO 6162	Controls dimensions and tolerances of code 61 and 62 port connections	Insures interchangeability and consistency
Forged Construction	Reliable, long life performance	No downtime, reduced costs
	Compact envelope size, no sharp edges	Reduced weight
Over 60 Configurations	Flexibility in plumbing, match system needs	Best solution and best value
Parflange Technology	Designed to be used with Code 61/62 fittings	Eliminates messy and time consuming brazing process
Mounting Hardware	Grade 8 bolts standard	Performs in rigorous applications for the life of the flange
Flange Kits	Flange with hardware for mounting (o-ring, bolts and lockwashers)	Reduces order and assembly error

Dimensions and pressures for reference only, subject to change.

Dual Seal Flange Adapters

Parker's Dual Seal Flange Adapter product line provides a solution for high vibration, high shock hydraulic four bolt connection styles used in various applications. This Parker innovation is offered as an alternative to traditional ISO 6121 (SAE J518) Code 62 Flange connections providing improved port retention, increased sealing capability and elimination of costly field replacement due to failure. Dual Seal Flange Adapters incorporate both radial and face seal technologies, reducing the potential for system leakage and ingress of air or water caused by side loading of traditional flange face seal connections.

Dual Seal Flange Adapters have a system working pressure rating of 7500 PSI with a 4:1 design factor. The face seal system incorporates Parker's Captive O-ring Groove technology to prevent o-ring fall out during installation minimizing connection failures seen with traditional flange connections.

Design and Construction

The Dual Seal Flange adapter consists of three components: a body, a face sealing O-ring and a radial sealing O-ring. The body is manufactured from Heat Code Traceable 316 stainless steel and the O-rings are manufactured from 90 durometer Nitrile. Additional components used for assembly of the Dual Seal Flange adapters include four bolts, flange clamps and lock washers. Flange clamps are available from Parker Tube Fittings Division, with standard sizes listed on Page L9 of this catalog section.

The Dual Seal Flange Adapter Body

Dual Seal Flange Adapters bodies are manufactured in ½", 1" and 1 ½" sizes with ten different cold drawn tube, pipe or hose end configurations available as standard. Straight bodies are machined from 316/316L bar stock.

Dual Seal Flange Clamps

Flange clamps are offered in both split and captive (one-piece) versions depending on the adapter configuration being used. Flange clamps are machined from 316/316L materials. For all straight Dual Seal Flange Adapter bodies split flange clamp are required. The 90° and 45° cast shaped versions can be installed with either split or captive flange clamps.

Industry Acceptance

Dual Seal Flange Adapters are designed to conform to bolt thread and bolt pattern dimensions of ISO 6162-2 or SAE J518 Code 62.

Materials used in the manufacture of Parker Dual Seal Flange Adapters are compliant to NACE MR0175. All products are Heat Code Traceable and have been tested to SAE requirements.

How Dual Seal Flange Adapters Work

As shown below, Dual Seal Flange connections use both a radial seal and face seal to achieve superior leak free port connection. The primary radial seal (A) improves the pressure capabilities of this adapter to 7500 PSI while offering additional system integrity. The face seal (B) provides resistance of external pressures introduced by the application environment. The flange clamps (C) and bolts (D) are used to compress the o-rings into the port and provide the clamping force necessary. Reference Fig. L5 below.

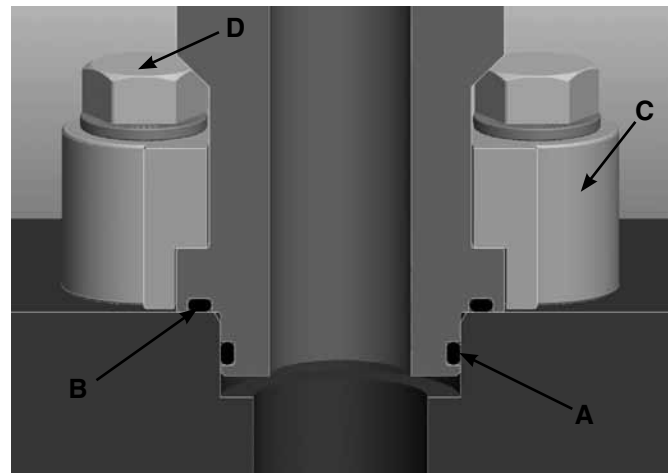

Fig. L5

Dimensions and pressures for reference only, subject to change.

The Parker Advantage

Improved Pressure Rating: Parker's new Dual Seal design is rated for up to 7500 PSI to meet current and future hydraulic design needs. This design has also been tested to meet standard SAE J1644 parameters.

Captive O-ring Groove: The design of Parker's Dual Seal Flange Adapters incorporates a captive O-ring groove (CORG) which prevents O-ring fall out during installation further preventing the possibility of leaks.

Radial Seal: The primary radial seal (A) improves the pressure capabilities of the Dual Seal system to 7500 PSI while offering additional system integrity.

Ingression Seal: Reduces the potential for side loading and ultimately connection failure in high impulse and high vibration applications.

Multiple Standard Configurations: Parker's Dual Seal Flange Adapter product line includes a variety of tube, pipe, and hose connection styles to meet hydraulic system design needs. Included are Parker's Seal-Lok (SAE J1453), Triple-Lok (SAE J514), SAE ORB (SAE J1926) and NPTF for traditional hydraulic connections. In addition, to offer a solution for schedule pipe assemblies, Parker offers socket weld configurations.

Code 61 and Code 62 Port Ends

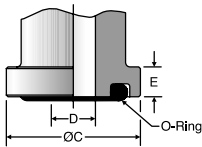

	Flange O.D.	Drill	Flange Height
SIZE	C (inch)	D Max (inch)	E (inch)
CODE 61			
8	1.19	0.50	0.265
12	1.50	0.75	0.265
16	1.75	1.00	0.315
20	2.00	1.25	0.315
24	2.38	1.50	0.315
32	2.81	2.00	0.375
CODE 62			
8	1.25	0.50	0.305
12	1.63	0.75	0.345
16	1.88	1.00	0.375
20	2.13	1.25	0.405
24	2.50	1.50	0.495
32	3.13	2.00	0.495

Port Ends for Dual Seal Flange Port

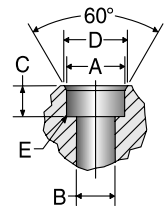

SIZE	A (in.)	B (in.)	C (in.)	D (CSK)	E (R)
8	0.750 - 0.752	0.500	0.400	.82 X 60°	0.02
16	1.375 - 1.377	0.938	0.400	1.445 X 60°	0.02
24	1.750 - 1.752	1.312	0.530	1.82 X 60°	0.02

Dimensions and pressures for reference only, subject to change.



FCS

Code 61/62 Flange Clamps, Split

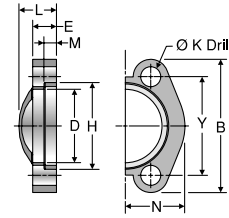

TUBE FITTING PART #	HOSE PRODUCTS PART #	HOSE PRODUCTS PART #	FLANGE SIZE (in.)	B (in.)	D (in.)	E (in.)	H (in.)	K DRILL DIA. (in.)	L (in.)	M (in.)	N (in.)	Y (in.)	MOUNTING HARDWARE HHCS	Dynamic Pressure (x 1,000 PSI)	
FLANGE HALF	FLANGE HALF	KIT												S	SS
CODE 61 FLANGE CLAMPS, SPLIT															
8FCS1	51H-8	5151HK-8	0.50	2.12	0.955	0.50	1.22	0.344	0.75	0.245	0.86	1.50	5/16-18 x 1.25	5.0	5.0
12FCS1	51H-12	5151HK-12	0.75	2.56	1.265	0.56	1.53	0.406	0.88	0.245	0.98	1.88	3/8-16 x 1.25	5.0	5.0
16FCS1	51H-16	5151HK-16	1.00	2.75	1.515	0.62	1.78	0.406	0.94	0.295	1.11	2.06	3/8-16 x 1.25	5.0	5.0
20FCS1	51H-20	5151HK-20	1.25	3.12	1.720	0.56	2.03	0.469	0.88	0.295	1.39	2.31	7/16-14 x 1.50	4.0	4.0
24FCS1	51H-24	5151HK-24	1.50	3.69	2.000	0.62	2.41	0.531	1.00	0.295	1.58	2.75	1/2-13 x 1.50	3.0	3.0
32FCS1	51H-32	5151HK-32	2.00	4.00	2.470	0.62	2.84	0.531	1.03	0.355	1.86	3.06	1/2-13 x 1.50	3.0	3.0
40FCS1	51H-40	5151HK-40	2.50	4.50	2.950	0.75	3.34	0.531	1.50	0.355	2.09	3.50	1/2-13 x 1.75	2.5	2.5
48FCS1	51H-48	5151HK-48	3.00	5.31	3.580	0.88	4.03	0.656	1.62	0.355	2.53	4.19	5/8-11 x 1.75	2.0	2.0
56FCS1	51H-56	5151HK-56	3.50	6.00	4.030	0.88	4.53	0.656	1.12	0.422	2.70	4.75	5/8-11 x 1.75	0.5	0.5
64FCS1	51H-64	5151HK-64	4.00	6.38	4.530	1.00	5.03	0.656	1.38	0.422	2.95	5.13	5/8-11 x 2.00	0.5	0.5
CODE 62 FLANGE CLAMPS, SPLIT															
12FCS2	HFH-12	HFHFHK-12	0.75	2.81	1.280	0.75	1.66	0.406	1.12	0.325	1.14	2.00	3/8-16 x 1.50	6.0	6.0
16FCS2	HFH-16	HFHFHK-16	1.00	3.19	1.530	0.94	1.91	0.469	1.31	0.355	1.33	2.25	7/16-14 x 1.75	6.0	6.0
20FCS2	HFH-20	HFHFHK-20	1.25	3.75	1.750	1.06	2.16	0.531	1.50	0.385	1.48	2.63	1/2-13 x 1.75	6.0	6.0
24FCS2	HFH-24	HFHFHK-24	1.50	4.44	2.030	1.19	2.53	0.656	1.69	0.475	1.83	3.13	5/8-11 x 2.25	6.0	6.0
32FCS2	HFH-32	HFHFHK-32	2.00	5.25	2.660	1.44	3.16	0.781	2.06	0.475	2.20	3.81	3/4-10 x 2.75	6.0	6.0

To order a flange clamp split kit, insert a "K" after the material designator in the Tube Fitting part number. The Kit includes two flange clamp halves, 4 HHCS bolts, 4 lock washers and an O-ring.

FCC

Code 61/62 Flange Clamp, Captive

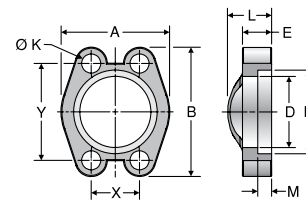

TUBE FITTING PART #	FLANGE SIZE (in.)	A (in.)	B (in.)	D (in.)	E (in.)	H (in.)	K DRILL DIA. (in.)	L (in.)	M (in.)	T TAP UN-2B (in.)	X (in.)	Y (in.)	MOUNTING HARDWARE HHCS	Dynamic Pressure (x 1,000 PSI)		
DRILLED HOLES	TAPPED HOLES													SX	SS	
CODE 61 FLANGE CLAMP, CAPTIVE																
8FCC1	8FCCT1	0.50	1.81	2.125	0.955	0.50	1.219	0.344	0.75	0.245	5/16-18	0.688	1.500	5/16-18 x 1.25	5.0	
12FCC1	12FCCT1	0.75	2.06	2.560	1.265	0.56	1.531	0.406	0.88	0.245	3/8-16	0.875	1.875	3/8-16 x 1.25	5.0	
16FCC1	16FCCT1	1.00	2.31	2.750	1.515	0.62	1.781	0.406	0.94	0.295	3/8-16	1.031	2.062	3/8-16 x 1.25	5.0	
20FCC1	20FCCT1	1.25	2.88	3.125	1.720	0.56	2.031	0.469	0.88	0.295	7/16-14	1.188	2.312	7/16-14 x 1.50	4.0	
24FCC1	24FCCT1	1.50	3.25	3.705	2.000	0.62	2.406	0.531	1.00	0.295	1/2-13	1.406	2.750	1/2-13 x 1.50	3.0	
32FCC1	32FCCT1	2.00	3.81	4.000	2.470	0.62	2.844	0.531	1.03	0.355	1/2-13	1.688	3.062	1/2-13 x 1.50	3.0	
40FCC1	40FCCT1	2.50	4.28	4.500	2.950	0.75	3.344	0.531	1.50	0.355	1/2-13	2.000	3.500	1/2-13 x 1.75	2.5	
48FCC1	48FCCT1	3.00	5.16	5.315	3.580	0.88	4.031	0.656	1.62	0.355	5/8-11	2.438	4.188	5/8-11 x 1.75	2.0	
56FCC1	56FCCT1	3.50	5.50	6.000	4.030	0.88	4.531	0.656	1.12	0.422	5/8-11	2.750	4.750	5/8-11 x 1.75	0.5	
64FCC1	64FCCT1	4.00	6.00	6.375	4.530	1.00	5.031	0.656	1.38	0.422	5/8-11	3.062	5.125	5/8-11 x 2.00	0.5	
CODE 62 FLANGE CLAMP, CAPTIVE																
12FCC2	12FCCT2	0.75	2.38	2.810	1.280	0.75	1.656	0.406	1.12	0.325	3/8-16	0.938	2.000	3/8-16 x 1.50	6.0	
16FCC2	16FCCT2	1.00	2.75	3.190	1.530	0.94	1.906	0.469	1.31	0.355	7/16-14	1.094	2.250	7/16-14 x 1.75	6.0	
20FCC2	20FCCT2	1.25	3.06	3.750	1.750	1.06	2.156	0.531	1.50	0.385	1/2-13	1.250	2.625	1/2-13 x 1.75	6.0	
24FCC2	24FCCT2	1.50	3.75	4.440	2.030	1.19	2.531	0.656	1.69	0.475	5/8-11	1.438	3.125	5/8-11 x 2.25	6.0	
32FCC2	32FCCT2	2.00	4.50	5.250	2.660	1.44	3.156	0.781	2.06	0.475	3/4-10	1.750	3.812	3/4-10 x 2.75	6.0	

Dimensions and pressures for reference only, subject to change.



FHS3

Flange Components

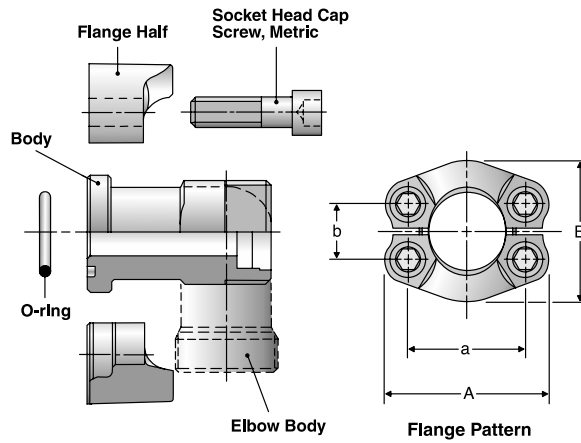

Code 61

For Straights and Elbows
(ISO 6162-1, Type 1)

Size	For Tube O.D. Series	Working Pressure (bar)	SAE Flange Halves	4 Socket Head Cap Screws DIN 912-8.8	O-Ring
1/2	15L	315	FHS 32CFX	M8X30	OR18.64 x 3.53X
1/2	16S	350			
3/4	18L	315	FHS 33CFX	M10X35	OR25.00 x 3.53X
3/4	22L	160			
3/4	20S	350			
3/4	25S	350			
1	28L	160	FHS 34CFX	M10X35	OR32.92 x 3.53X
1	30S	350			
1 1/4	35L	160	FHS 35CFX	M12X40*	OR37.70 x 3.53X
1 1/4	25S	280			
1 1/4	30S	280			
1 1/4	38S	280			
1 1/2	42L	160	FHS 36CFX	M12X40	OR47.22 x 3.53X
1 1/2	38S	210			

Size	For Tube O.D. Series	A ≈	B ≈	a	b
1/2	15L	54	46	38.1	17.5
1/2	16S	54	46	38.1	17.5
3/4	18L	65	52	47.6	22.2
3/4	22L	65	52	47.6	22.2
3/4	20S	65	52	47.6	22.2
3/4	25S	65	52	47.6	22.2
1	28L	70	59	52.4	26.2
1	30S	70	59	52.4	26.2
1 1/4	35L	79	73	58.7	30.2
1 1/4	25S	79	73	58.7	30.2
1 1/4	30S	79	73	58.7	30.2
1 1/4	38S	79	73	58.7	30.2
1 1/2	42L	94	83	69.9	35.7
1 1/2	38S	94	83	69.9	35.7

Temperature range without pressure reductions for fittings with O-ring sealing of NBR (e.g., buna N series) -35°C up to +100°C, FPM (e.g., fluorocarbon on request) -25°C up to +120°C.

Tightening torques for socket head cap screws see Table S6.

* Does not meet ISO 6162 specification.

Note: Clamp halves are sold separately, not as a set.

Dimensions and pressures for reference only, subject to change.

FHS6

Flange Components

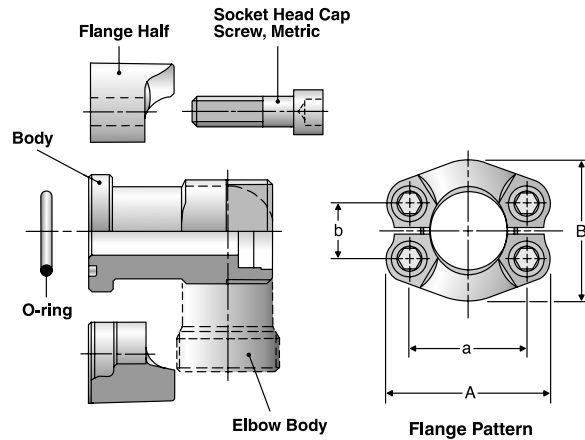

Code 62

For Straights and Elbows
(ISO 6162-2, Type 1)

Size	For Tube O.D. Series	Working Pressure (bar)	SAE Flange Halves	4 Socket Head Cap Screws DIN 912-8.8	O-Ring
1/2	16S	400	FHS 62CFX	M8X35	OR18.64 x 3.53X
3/4	16S	400	FHS 63CFX	M10X35	OR25.00 x 3.53X
3/4	20S	400	FHS 63CFX	M10X35	OR25.00 x 3.53X
3/4	25S	400	FHS 63CFX	M10X35	OR25.00 x 3.53X
1	25S	400	FHS 64CFX	M12X45	OR32.92 x 3.53X
1	30S	400	FHS 64CFX	M12X45	OR32.92 x 3.53X
1 1/4	30S	400	FHS 65CFX	M14X50*	OR37.70 x 3.53X
1 1/4	38S	315	FHS 65CFX	M14X50*	OR37.70 x 3.53X
1 1/2	38S	315	FHS 66CFX	M16X55	OR47.22 x 3.53X

Size	For Tube O.D. Series	A ≈	a	B ≈	b
1/2	16S	56	40.5	47	18.2
3/4	16S	71	50.8	60	23.8
3/4	20S	71	50.8	60	23.8
3/4	25S	71	50.8	60	23.8
1	25S	81	57.2	70	27.8
1	30S	81	57.2	70	27.8
1 1/4	30S	95	66.7	77	31.8
1 1/4	38S	95	66.7	77	31.8
1 1/2	38S	113	79.4	95	36.5

Temperature range without pressure reductions for fittings with O-ring sealing of NBR (e.g., buna N series) -35° up to +100°C, FPM (e.g., fluorocarbon on request) -25° up to +120°C.

Tightening torques for socket head cap screws see Table S7.

* Does not meet ISO 6162 specification.

Note: Clamp halves are sold separately, not as a set.

Dimensions and pressures for reference only, subject to change.

LOHQ1

Code 61 Flange Connector
Code 61 / ORFS

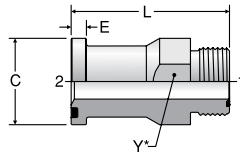

* Y – Across Wrench Flats

TUBE FITTING PART #	END SIZE		C (in.)	E (in.)	L (in.)	Y (in.)	Dynamic Pressure (x 1,000 PSI) -S
	1 (in.)	2 Code 61					
12 LOHQ1	3/4	3/4	1.500	0.265	2.79	1 3/8	5.0
16 LOHQ1	1	1	1.750	0.315	2.81	1 5/8	5.0
20 LOHQ1	1 1/4	1 1/4	2.000	0.315	3.21	1 7/8	4.0
24 LOHQ1	1 1/2	1 1/2	2.375	0.315	3.29	2 1/8	3.0

LOHQ2

Code 62 Flange Connector
Code 62 / ORFS

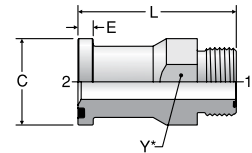

* Y – Across Wrench Flats

TUBE FITTING PART #	END SIZE		C (in.)	E (in.)	L (in.)	Y (in.)	Dynamic Pressure (x 1,000 PSI) -S
	1 (in.)	2 Code 62					
12 LOHQ2	3/4	3/4	1.625	0.345	3.02	1 3/8	6.0
12-16 LOHQ2	3/4	1	1.875	0.375	3.34	1 5/8	6.0
16 LOHQ2	1	1	1.875	0.375	3.36	1 5/8	6.0
20 LOHQ2	1 1/4	1 1/4	2.125	0.405	3.48	1 7/8	5.0
24 LOHQ2	1 1/2	1 1/2	2.500	0.495	4.14	2 1/8	4.5

XHQ1

Code 61 Flange Connector
Code 61 / 37° Flare

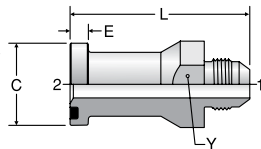

* Y – Across Wrench Flats

TUBE FITTING PART #	END SIZE		C (in.)	E (in.)	L (in.)	Y (in.)	Dynamic Pressure (x 1,000 PSI) -S
	1 (in.)	2 Code 61					
12 XHQ1	3/4	3/4	1.500	0.265	2.77	1 3/8	5.0
16 XHQ1	1	1	1.750	0.315	2.91	1 5/8	5.0
20 XHQ1	1 1/4	1 1/4	2.000	0.315	3.36	1 7/8	4.0
24 XHQ1	1 1/2	1 1/2	2.375	0.315	3.57	2 1/8	3.0
32 XHQ1	2	2	2.812	0.375	4.04	2 5/8	2.0

XHQ2

Code 62 Flange Connector
Code 62 / 37° Flare

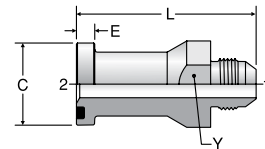

* Y – Across Wrench Flats

TUBE FITTING PART #	END SIZE		C (in.)	E (in.)	L (in.)	Y (in.)	Dynamic Pressure (x 1,000 PSI) -S
	1 (in.)	2 Code 62					
12 XHQ2	3/4	3/4	1.625	0.345	3.08	1 3/8	5.0
16 XHQ2	1	1	1.875	0.375	3.43	1 5/8	5.0
20 XHQ2	1 1/4	1 1/4	2.125	0.405	3.60	1 7/8	4.0
24 XHQ2	1 1/2	1 1/2	2.500	0.495	4.34	2 1/8	3.0

BUHQ1

Code 61 Connector
Code 61 / Flareless

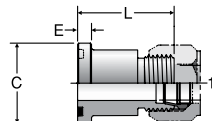

TUBE FITTING PART #	END SIZE		C (in.)	E (in.)	L (in.)	Dynamic Pressure (x 1,000 PSI) -S
	1 (in.)	2 Code 61				
12 BUHQ1	3/4	3/4	1.500	0.265	1.82	
16 BUHQ1	1	1	1.750	0.315	1.88	
20 BUHQ1	1 1/4	1 1/4	2.000	0.315	1.82	
24 BUHQ1	1 1/2	1 1/2	2.375	0.315	1.94	
32 BUHQ1	2	2	2.812	0.375	1.97	

Dimensions and pressures for reference only, subject to change.

F50HQ1

Code 61 Connector
Code 61 / SAE-ORB

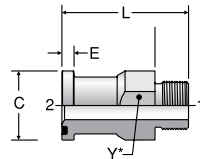

* Y – Across Wrench Flats

F50HQ2

Code 62 Connector
Code 62 / SAE-ORB

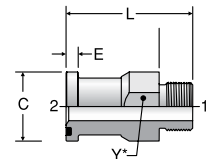

* Y – Across Wrench Flats

TUBE FITTING PART #	END SIZE		C (in.)	E (in.)	L (in.)	Y (in.)	Dynamic Pressure (x 1,000 PSI) -S
	1 (in.)	2 Code 61					
12 F50HQ1	3/4	3/4	1.500	0.265	2.63	1 3/8	5.0
16 F50HQ1	1	1	1.750	0.315	2.73	1 5/8	4.5
20 F50HQ1	1 1/4	1 1/4	2.000	0.315	3.13	1 7/8	4.0
24 F50HQ1	1 1/2	1 1/2	2.375	0.315	3.22	2 1/8	3.0
32 F50HQ1	2	2	2.812	0.375	3.49	2 3/4	3.0

TUBE FITTING PART #	END SIZE		C (in.)	E (in.)	L (in.)	Y (in.)	Dynamic Pressure (x 1,000 PSI) -S
	1 (in.)	2 Code 62					
12 F50HQ2	3/4	3/4	1.625	0.345	3.08	1 3/8	6.0
16 F50HQ2	1	1	1.875	0.375	3.25	1 5/8	5.5
20 F50HQ2	1 1/4	1 1/4	2.125	0.405	3.37	1 7/8	4.5
24 F50HQ2	1 1/2	1 1/2	2.500	0.495	3.99	2 1/8	4.0
32 F50HQ2	2	2	3.125	0.495	4.86	2 3/4	3.0

B3HQ

Braze Flange Head Connector, Tube
Tube Braze Socket* / Code 61/62 Flange Head

* For clearance brazing

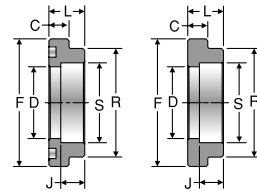

O-ring Face Flat Face

TUBE FITTING PART #	FLANGE SIZE (in.)	TUBE O.D. (in.)	C (in.)	D (in.)	F (in.)	J (in.)	L (in.)	R (in.)	S (in.)	Dynamic Pressure (x 1,000 PSI)		
										SX	SS	
TUBE BRAZE SOCKET / CODE 61 FLANGE HEAD												
8B3HQ1	8B3HQ1N	0.50	1/2	0.265	0.406	1.188	0.312	0.50	0.940	0.502	5.0	
10-8B3HQ1	10-8B3HQ1N	0.50	5/8	0.265	0.500	1.188	0.312	0.50	0.940	0.625	5.0	
12B3HQ1	12B3HQ1N	0.75	3/4	0.265	0.656	1.500	0.375	0.56	1.250	0.752	4.5	
16-12B3HQ1	16-12B3HQ1N	0.75	1	0.315	0.750	1.500	0.375	0.56	1.250	1.002	4.5	
16B3HQ1	16B3HQ1N	1.00	1	0.315	0.906	1.750	0.375	0.56	1.500	1.002	4.5	
20-16B3HQ1	20-16B3HQ1N	1.00	1 1/4	0.315	1.000	1.750	0.375	0.56	1.500	1.252	4.0	
20B3HQ1	20B3HQ1N	1.25	1 1/4	0.315	1.125	2.000	0.375	0.56	1.700	1.252	3.5	
24-20B3HQ1	24-20B3HQ1N	1.25	1 1/2	0.315	1.250	2.000	0.375	0.56	1.700	1.502	3.5	
24B3HQ1	24B3HQ1N	1.50	1 1/2	0.315	1.375	2.380	0.438	0.62	1.980	1.502	3.0	
28-24B3HQ1	28-24B3HQ1N	1.50	1 3/4	0.315	1.500	2.380	0.438	0.62	1.980	1.752	2.7	
32B3HQ1	32B3HQ1N	2.00	2	0.375	1.875	2.810	0.500	0.62	2.450	2.002	3.0	
36-32B3HQ1	36-32B3HQ1N	2.00	2 1/4	0.375	2.000	2.810	0.500	0.62	2.450	2.252	3.0	
40B3HQ1	40B3HQ1N	2.50	2 1/2	0.375	2.375	3.312	0.562	0.68	2.921	2.502	2.2	
44-40B3HQ1	44-40B3HQ1N	2.50	2 3/4	0.375	2.500	3.312	0.500	0.68	2.921	2.752	2.2	
48B3HQ1	48B3HQ1N	3.00	3	0.375	2.875	4.000	0.562	0.75	3.546	3.002	1.7	
TUBE BRAZE SOCKET / CODE 62 FLANGE HEAD												
12B3HQ2	12B3HQ2N	0.75	3/4	0.345	0.656	1.625	0.500	0.69	1.250	0.752	6.0	
16-12B3HQ2	16-12B3HQ2N	0.75	1	0.345	0.750	1.625	0.500	0.69	1.250	1.002	6.0	
16B3HQ2	16B3HQ2N	1.00	1	0.375	0.810	1.875	0.625	0.81	1.500	1.002	6.0	
20-16B3HQ2	20-16B3HQ2N	1.00	1 1/4	0.375	1.000	1.875	0.625	0.81	1.500	1.252	6.0	
20B3HQ2	20B3HQ2N	1.25	1 1/4	0.405	1.010	2.125	0.812	1.00	1.718	1.252	6.0	
24-20B3HQ2	24-20B3HQ2N	1.25	1 1/2	0.405	1.250	2.125	0.812	1.00	1.718	1.502	5.5	
24B3HQ2	24B3HQ2N	1.50	1 1/2	0.495	1.250	2.500	1.000	1.19	2.000	1.502	6.0	
28-24B3HQ2	28-24B3HQ2N	1.50	1 3/4	0.495	1.500	2.500	1.000	1.19	2.000	1.752	4.5	
32B3HQ2	32B3HQ2N	2.00	2	0.495	1.750	3.125	1.375	1.50	2.620	2.002	5.5	
36-32B3HQ2	36-32B3HQ2N	2.00	2 1/4	0.495	2.000	3.125	1.312	1.50	2.620	2.252	4.0	

Dimensions and pressures for reference only, subject to change.

GFS

SAE Flange Connector – Standard Series
Code 61 & 62 / Metric Flareless

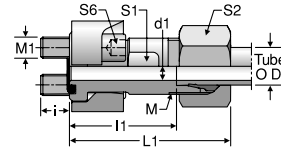

TUBE FITTING PART #	SIZE (in.)	TUBE O.D. (mm)	WORKING PRESSURE (bar)	M THREAD	d1 (mm)	i (mm)	L1 (mm)	L1 ≈ (mm)	S1 (mm)	S2 (mm)	S6 (mm)	MATERIAL FROM STOCK		EO-2 FROM STOCK	
												CF	71	CF	71
SAE FLANGE CONNECTIONS – CODE 61 – STANDARD SERIES															
GFS32/15LCF	1/2	15L	200	M22 x 1.5	12	11.5	41	56	24	27	6	•		•	
GFS32/16SCF	1/2	16S	220	M24 x 1.5	12	11.5	41.5	60	24	30	6	•		•	
GFS33/18LCF	3/4	18L	200	M26 x 1.5	15	15.5	45.5	62	30	32	8	•		•	
GFS33/22LCF	3/4	22L	100	M30 x 2	19	15.5	45.5	62	30	36	8	•		•	
GFS33/20SCF	3/4	20S	220	M30 x 2	16	15.5	46.5	68	30	36	8	•		•	
GFS33/25SCF	3/4	25S	220	M36 x 2	17	15.5	45	69	30	46	8	•		•	
GFS34/28LCF	1	28L	100	M36 x 2	24	13.5	46.5	63	36	41	8	•		•	
GFS34/30SCF	1	30S	220	M42 x 2	24	13.5	49.5	76	36	50	8	•		•	
GFS35/35LCF	1 1/4	35L	100	M45 x 2	30	18.5	47.5	69	41	50	8	•		•	
GFS35/25SCF	1 1/4	25S	175	M36 x 2	20	18.5	48	72	41	46	8	•		•	
GFS35/30SCF	1 1/4	30S	175	M42 x 2	25	18.5	48.5	75	41	50	8	•		•	
GFS35/38SCF	1 1/4	38S	175	M52 x 2	28	18.5	50	81	46	60	8	•		•	
GFS36/42LCF	1 1/2	42L	100	M52 x 2	36	18.5	53	76	46	60	10	•		•	
GFS36/38SCF	1 1/2	38S	130	M52 x 2	32	18.5	54	85	46	60	10	•		•	
SAE FLANGE CONNECTIONS – CODE 62 – HIGH PRESSURE SERIES															
GFS62/16SCF	1/2	16S	250	M24 x 1.5	12	13.5	44.5	63	24	30	6	•		•	
GFS63/16SCF	3/4	16S	250	M24 x 1.5	12	15.5	50.5	69	30	30	8	•		•	
GFS63/20SCF	3/4	20S	250	M30 x 2	16	15.5	50.5	72	30	36	8	•		•	
GFS63/25SCF	3/4	25S	250	M36 x 2	17	15.5	51	75	30	46	8	•		•	
GFS64/25SCF	1	25S	250	M36 x 2	20	20.5	60	84	36	46	10	•		•	
GFS64/30SCF	1	30S	250	M42 x 2	24	20.5	60.5	87	36	50	10	•		•	
GFS65/30SCF	1 1/4	30S	250	M42 x 2	25	22.5	65.5	92	41	50	10	•		•	
GFS65/38SCF	1 1/4	38S	200	M52 x 2	30	22.5	67	98	46	60	10	•		•	
GFS66/38SCF	1 1/2	38S	200	M52 x 2	30	24.5	73	104	46	60	14	•		•	

EO-2 Part Number example: GFS33/18ZLCF

Temperature range without pressure reductions for fittings with O-ring sealing of NBR (e.g., buna N series) -35°C up to +100°C, FPM (e.g., fluorocarbon on request) -25°C up to +120°C.

Tightening torques for socket head cap screws see Tables S6 and S7.

Dimensions and pressures for reference only, subject to change.

BFG

DIN Flange / Metric Flareless

Tube connection according to DIN 2353

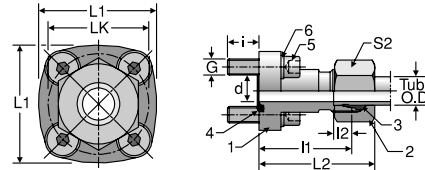

TUBE FITTING PART #	WORKING PRESSURE (bar)	TUBE O.D. (mm)	d (mm)	G	i (mm)	I1 (mm)	I2 (mm)	L1 (mm)	L2 (mm)	LK (mm)	S2 (mm)	MATERIAL FROM STOCK		EO-2 FROM STOCK	
												CF	71	CF	71
BFG15L/LK40CF	65	15	12	M 6	12.5	35	7	42	43	40	27	•		•	
BFG18L/LK40CF	65	18	15	M 6	12.5	35	7.5	42	44	40	32	•		•	
BFG22L/LK40CF	65	22	19	M 6	12.5	35	7.5	42	44.5	40	36	•		•	
BFG15L/LK35CF	155	15	12	M 6	12.5	30	7	39	38	35	27	•		•	
BFG10L/LK35CF	200	10	8	M 6	12.5	30	7	39	39	35	19	•		•	
BFG12L/LK35CF	200	12	10	M 6	12.5	30	7	39	39	35	22	•		•	

Unassembled BFG Fitting Components

1 Straight Body	2 Nut	3 Progressive Ring	4 O-Ring	5 Cap Screws DIN 912-8.8 (4 pcs.)	6 Spring Washer DIN 127 (4 pcs.)
BFG15L/LK40CFX	M15LCFX	DPR15LCFX	OR26X2.5X	M6X22	A6
BFG15L/LK40CFX	M18LCFX	DPR18LCFX	OR26X2.5X	M6X22	A6
BFG22L/LK40CFX	M22LCFX	DPR22LCFX	OR26X2.5X	M6X22	A6
BFG15L/LK35CFX	M15LCFX	DPR15LCFX	OR20X2.5X	M6X22	A6
BFG10L/LK35CFX	M10LCFX	DPR10LCFX	OR20X2.5X	M6X22	A6
BFG12L/LK35CFX	M12LCFX	DPR12LCFX	OR20X2.5X	M6X22	A6

EO-2 Part Number example: BFG15ZL/LK40CF

Temperature range without pressure reductions for fittings with O-ring sealing of NBR (e.g., buna N series) -35°C up to +100°C, FPM (e.g., fluorocarbon on request) -25°C up to 120°C.

Tightening torques for socket head cap screws see Table S6.

P

Flange Head Plug
Code 61/62 Flange Head Plug

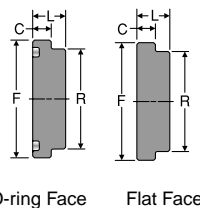

O-ring Face Flat Face

TUBE FITTING PART #		FLANGE SIZE (in.)	C (in.)	F (in.)	L (in.)	R (in.)	Dynamic Pressure (x 1,000 PSI)	
O-RING FACE	FLAT FACE						SX	SS
CODE 61 FLANGE HEAD PLUG								
8PQ1	8PQ1N	0.50	0.265	1.188	0.500	0.940	5.0	
12PQ1	12PQ1N	0.75	0.265	1.500	0.560	1.250	5.0	
16PQ1	16PQ1N	1.00	0.315	1.750	0.560	1.500	5.0	
20PQ1	20PQ1N	1.25	0.315	2.000	0.560	1.700	4.0	
24PQ1	24PQ1N	1.50	0.315	2.380	0.620	1.980	3.0	
32PQ1	32PQ1N	2.00	0.375	2.810	0.620	2.450	3.0	
40PQ1	40PQ1N	2.50	0.375	3.312	0.680	2.921	2.5	
48PQ1	48PQ1N	3.00	0.375	4.000	0.750	3.546	2.0	
CODE 62 FLANGE HEAD PLUG								
12PQ2	12PQ2N	0.75	0.345	1.625	0.687	1.250	6.0	
16PQ2	16PQ2N	1.00	0.375	1.875	0.812	1.500	6.0	
20PQ2	20PQ2N	1.25	0.405	2.125	1.000	1.718	6.0	
24PQ2	24PQ2N	1.50	0.495	2.500	1.187	2.000	6.0	
32PQ2	32PQ2N	2.00	0.495	3.125	1.500	2.625	6.0	

Dimensions and pressures for reference only, subject to change.

W7HQ

Weld Socket Flange Connector, Pipe
Extended Weld Socket, Pipe / Code 61 or 62 Flange Head

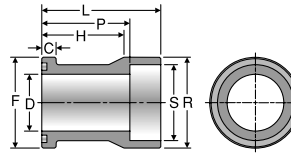

TUBE FITTING PART #	PIPE SIZE (in.)	FLANGE SIZE (in.)	C (in.)	D (in.)	F (in.)	H (in.)	L (in.)	P (in.)	R (in.)	S (in.)	Dynamic Pressure (x 1,000 PSI)	
											SX	SS
EXTENDED WELD SOCKET, PIPE / CODE 61 FLANGE HEAD												
12W7HQ1	3/4	0.75	0.265	0.750	1.500	1.62	2.34	1.78	1.500	1.062	3.5	
16W7HQ1	1	1.00	0.315	1.000	1.750	1.62	2.38	1.75	1.750	1.328	3.5	
20W7HQ1	1 1/4	1.25	0.315	1.250	2.000	1.81	2.62	1.94	2.000	1.672	3.5	
24W7HQ1	1 1/2	1.50	0.315	1.500	2.375	2.00	2.88	2.12	2.375	1.922	2.7	
32W7HQ1	2	2.00	0.375	2.000	2.812	2.00	3.00	2.12	2.812	2.406	2.5	
EXTENDED WELD SOCKET, PIPE / CODE 62 FLANGE HEAD												
16W7HQ2	1	1.00	0.375	1.000	1.875	2.34	3.06	2.43	2.000	1.328	5.5	
20W7HQ2	1 1/4	1.25	0.405	1.125	2.125	2.50	3.31	2.62	2.312	1.672	5.5	
24W7HQ2	1 1/2	1.50	0.495	1.375	2.500	3.06	3.93	3.18	2.750	1.922	5.5	
32W7HQ2	2	2.00	0.495	1.875	3.125	3.18	4.06	3.18	3.250	2.406	5.0	

GHQ / G5HQ

Threaded Port Flange Adapter
NPTF or SAE Port / Code 61 Flange Head

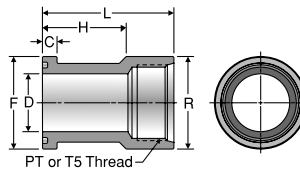

GHQ

TUBE FITTING PART #	PT PORT THREAD NPTF	FLANGE SIZE (in.)	C (in.)	D (in.)	F (in.)	H (in.)	L (in.)	R (in.)	Dynamic Pressure (x 1,000 PSI)	
									SX	SS
NPTF PORT / CODE 61 FLANGE HEAD										
12GHQ1	3/4-14	0.75	0.265	0.75	1.500	1.62	2.47	1.50	4.0	
16GHQ1	1-11 1/2	1.00	0.315	1.00	1.750	1.62	2.66	1.75	4.0	
20GHQ1	1 1/4-11 1/2	1.25	0.315	1.25	2.000	1.81	2.84	2.00	3.0	
24GHQ1	1 1/2-11 1/2	1.50	0.315	1.50	2.375	2.00	3.00	2.38	2.0	
32GHQ1	2-11 1/2	2.00	0.375	2.00	2.812	2.00	3.00	2.81	2.0	

G5HQ

TUBE FITTING PART #	T5 PORT THREAD UN-2B	SAE PORT DASH SIZE	FLANGE SIZE (in.)	C (in.)	D (in.)	F (in.)	H (in.)	L (in.)	R (in.)	Dynamic Pressure (x 1,000 PSI)	
										SX	SS
SAE PORT / CODE 61 FLANGE HEAD											
12G5HQ1	1 1/6-12	12	0.75	0.265	0.75	1.500	1.62	2.47	1.50	4.0	
16G5HQ1	1 5/16-12	15	1.00	0.315	1.00	1.750	1.62	2.66	1.75	3.0	
20G5HQ1	1 5/8-12	20	1.25	0.315	1.25	2.000	1.81	2.84	2.00	2.2	
24G5HQ1	1 7/8-12	24	1.50	0.315	1.50	2.375	2.00	3.00	2.38	2.5	
32G5HQ1	2 1/2-12	32	2.00	0.375	2.00	2.812	2.00	3.00	2.81	1.2	

Dimensions and pressures for reference only, subject to change.

WB1HQ1 / WB3HQ1 / WB5HQ1

Code 61 Weld Butt Flange
Connector, Pipe
Schedule 40, 80 or 160 Weld Butt /
Code 61 Flange Head

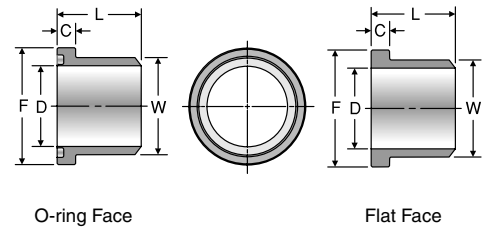

WELD BUTT FLANGE CONNECTION TYPE	TUBE FITTING PART #		PIPE SIZE (in.)	FLANGE SIZE (in.)	C (in.)	D (in.)	F (in.)	L (in.)	W (in.)	Dynamic Pressure (x 1,000 PSI)	
	O-RING FACE	FLAT FACE								SX	SS
SCHEDULE 40 WELD BUTT / CODE 61 FLANGE HEAD											
WB1HQ1 For Schedule 40 pipe	8WB1HQ1	8WB1HQ1N	1/2	0.50	0.265	0.622	1.188	1.06	0.840	5.3	
	12WB1HQ1	12WB1HQ1N	3/4	0.75	0.265	0.824	1.500	1.06	1.050	4.6	
	16WB1HQ1	16WB1HQ1N	1	1.00	0.315	1.049	1.750	1.25	1.315	4.0	
	20WB1HQ1	20WB1HQ1N	1 1/4	1.25	0.315	1.380	2.000	1.44	1.660	3.6	
	24WB1HQ1	24WB1HQ1N	1 1/2	1.50	0.315	1.610	2.375	1.75	1.900	3.0	
	32WB1HQ1	32WB1HQ1N	2	2.00	0.375	2.067	2.812	2.00	2.375	2.6	
	40WB1HQ1	40WB1HQ1N	2 1/2	2.50	0.375	2.469	3.312	2.31	2.875	2.6	
48WB1HQ1	48WB1HQ1N	3	3.00	0.375	3.068	4.000	2.32	3.500	2.3		
SCHEDULE 80 WELD BUTT / CODE 61 FLANGE HEAD											
WB3HQ1 For Schedule 80 pipe	8WB3HQ1	8WB3HQ1N	1/2	0.50	0.265	0.546	1.188	1.06	0.840	5.0	
	12WB3HQ1	12WB3HQ1N	3/4	0.75	0.265	0.742	1.500	1.06	1.050	3.5	
	16WB3HQ1	16WB3HQ1N	1	1.00	0.315	0.957	1.750	1.25	1.315	4.0	
	20WB3HQ1	20WB3HQ1N	1 1/4	1.25	0.315	1.278	2.000	1.44	1.660	3.5	
	24WB3HQ1	24WB3HQ1N	1 1/2	1.50	0.315	1.500	2.375	1.75	1.900	3.0	
	32WB3HQ1	32WB3HQ1N	2	2.00	0.375	1.939	2.812	2.00	2.375	3.0	
	40WB3HQ1	40WB3HQ1N	2 1/2	2.50	0.375	2.323	3.312	2.31	2.875	2.7	
48WB3HQ1	48WB3HQ1N	3	3.00	0.375	2.900	4.000	2.32	3.500	2.2		
SCHEDULE 160 WELD BUTT / CODE 61 FLANGE HEAD											
WB5HQ1 For Schedule 160 pipe	8WB5HQ1	8WB5HQ1N	1/2	0.50	0.265	0.464	1.188	1.06	0.840	5.0	
	12WB5HQ1	12WB5HQ1N	3/4	0.75	0.265	0.614	1.500	1.06	1.050	4.0	
	16WB5HQ1	16WB5HQ1N	1	1.00	0.315	0.815	1.750	1.25	1.315	4.5	
	20WB5HQ1	20WB5HQ1N	1 1/4	1.25	0.315	1.160	2.000	1.44	1.660	4.0	
	24WB5HQ1	24WB5HQ1N	1 1/2	1.50	0.315	1.337	2.375	1.75	1.900	3.0	
	32WB5HQ1	32WB5HQ1N	2	2.00	0.375	1.689	2.812	2.00	2.375	3.0	
	40WB5HQ1	40WB5HQ1N	2 1/2	2.50	0.375	2.125	3.312	2.31	2.875	2.5	
48WB5HQ1	48WB5HQ1N	3	3.00	0.375	2.624	4.000	2.32	3.500	2.0		

WB3HQ2 / WB5HQ2 / WB7HQ2

Code 62 Weld Butt Flange
Connector, Pipe
Schedule 80, 160 or
XXS Weld Butt / Code 62
Flange Head

WELD BUTT FLANGE CONNECTION TYPE	TUBE FITTING PART #		PIPE SIZE (in.)	FLANGE SIZE (in.)	C (in.)	D (in.)	F (in.)	L (in.)	W (in.)	Dynamic Pressure (x 1,000 PSI)	
	O-RING FACE	FLAT FACE								SX	SS
SCHEDULE 80 WELD BUTT / CODE 62 FLANGE HEAD											
WB3HQ2 For Schedule 80 pipe	12WB3HQ2	12WB3HQ2N	3/4	0.75	0.345	0.742	1.625	1.42	1.050	5.0	
	16WB3HQ2	16WB3HQ2N	1	1.00	0.375	0.957	1.875	1.61	1.315	4.5	
	20WB3HQ2	20WB3HQ2N	1 1/4	1.25	0.405	1.278	2.125	1.73	1.660	3.5	
	24WB3HQ2	24WB3HQ2N	1 1/2	1.50	0.495	1.500	2.500	2.17	1.900	3.0	
	32WB3HQ2	32WB3HQ2N	2	2.00	0.495	1.939	3.125	2.48	2.375	3.0	
SCHEDULE 160 WELD BUTT / CODE 62 FLANGE HEAD											
WB5HQ2 For Schedule 160 pipe	12WB5HQ2	12WB5HQ2N	3/4	0.75	0.345	0.614	1.625	1.42	1.050	6.0	
	16WB5HQ2	16WB5HQ2N	1	1.00	0.375	0.815	1.875	1.61	1.315	5.5	
	20WB5HQ2	20WB5HQ2N	1 1/4	1.25	0.405	1.160	2.125	1.73	1.660	5.0	
	24WB5HQ2	24WB5HQ2N	1 1/2	1.50	0.495	1.337	2.500	2.17	1.900	5.0	
	32WB5HQ2	32WB5HQ2N	2	2.00	0.495	1.689	3.125	2.48	2.375	4.5	
SCHEDULE XXS WELD BUTT / CODE 62 FLANGE HEAD											
WB7HQ2 For Schedule XXS pipe	12WB7HQ2	12WB7HQ2N	3/4	0.75	0.345	0.434	1.625	1.42	1.050	6.0	
	16WB7HQ2	16WB7HQ2N	1	1.00	0.375	0.599	1.875	1.61	1.315	6.0	
	20WB7HQ2	20WB7HQ2N	1 1/4	1.25	0.405	0.896	2.125	1.73	1.660	6.0	
	24WB7HQ2	24WB7HQ2N	1 1/2	1.50	0.495	1.100	2.500	2.17	1.900	6.0	
	32WB7HQ2	32WB7HQ2N	2	2.00	0.495	1.503	3.125	2.48	2.375	6.0	

Dimensions and pressures for reference only, subject to change.



G5Q

SAE Port Block Adapter
SAE Port / Code 61 or 62 Block Flange or Pad

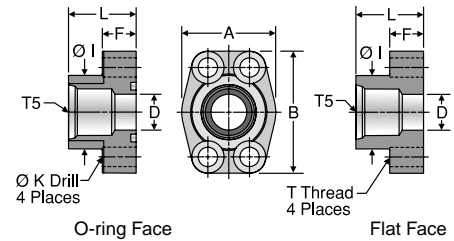

TUBE FITTING PART #		SAE PORT DASH SIZE	T5 STRAIGHT THREAD UN-2B	FLANGE SIZE (in.)	A (in.)	B (in.)	D (in.)	F (in.)	I (in.)	K DRILL DIA. (in.)	L (in.)	T THREAD UNC-2B	MOUNTING HARDWARE -SHCS	Dynamic Pressure (x 1,000 PSI)	
O-RING FACE	FLAT FACE													SX	SS ¹
SAE PORT / CODE 61 BLOCK FLANGE OR PAD															
8G5Q1B	8G5Q1P	8	3/4-16	0.50	1.81	2.13	0.50	0.63	1.25	0.344	1.42	5/16-18	5/16-18 x 1.25	5.0	
12G5Q1B	12G5Q1P	12	1 1/16-12	0.75	1.97	2.56	0.75	0.71	1.54	0.406	1.42	3/8-16	3/8-16 x 1.50	4.0	
16G5Q1B	16G5Q1P	16	1 5/16-12	1.00	2.17	2.75	1.00	0.71	1.81	0.406	1.50	3/8-16	3/8-16 x 1.50	3.5	
20G5Q1B	20G5Q1P	20	1 5/8-12	1.25	2.68	3.12	1.25	0.83	2.22	0.469	1.61	7/16-14	7/16-14 x 1.75	3.0	
24G5Q1B	24G5Q1P	24	1 7/8-12	1.50	3.07	3.66	1.50	0.98	2.50	0.531	1.77	1/2-13	1/2-13 x 1.75	2.5	
SAE PORT / CODE 62 BLOCK FLANGE OR PAD															
8G5Q2B	8G5Q2P	8	3/4-16	0.50	1.81	2.21	0.50	0.63	1.33	0.344	1.42	5/16-18	5/16-18 x 1.25	6.0	
12G5Q2B	12G5Q2P	12	1 1/16-12	0.75	2.17	2.80	0.75	0.83	1.65	0.406	1.38	3/8-16	3/8-16 x 1.50	5.5	
16G5Q2B	16G5Q2P	16	1 5/16-12	1.00	2.56	3.19	1.00	0.98	1.98	0.409	1.65	7/16-14	7/16-14 x 1.75	4.5	
20G5Q2B	20G5Q2P	20	1 5/8-12	1.25	3.07	3.75	1.25	1.06	2.36	0.531	1.77	1/2-13	1/2-13 x 1.75	3.0	
24G5Q2B	24G5Q2P	24	1 7/8-12	1.50	3.70	4.41	1.50	1.18	2.68	0.656	1.97	5/8-11	5/8-11 x 2.25	2.7	
32G5Q2B	32G5Q2P	32	2 1/2-12	2.00	4.50	5.28	2.00	1.46	3.38	0.781	2.56	3/4-10	3/4-10 x 2.75	2.0	

1) See page L38 for standard stainless steel sizes and dimensions.

To receive mounting hardware with flange, insert a "K" after the material designator. Mounting hardware kits are available for O-ring Face part numbers and include 4 bolts, 4 lock washers and an O-ring.

GQ

NPTF Port Block Adapter
NPTF Port / Code 61 or 62 Block Flange or Pad

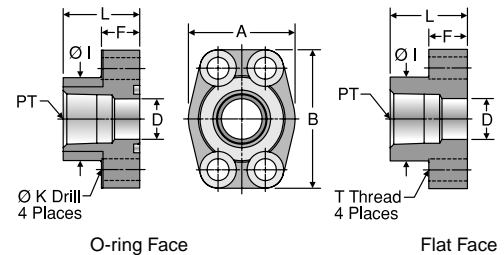

TUBE FITTING PART #		PT PORT THREAD NPTF	FLANGE SIZE (in.)	A (in.)	B (in.)	D (in.)	F (in.)	I (in.)	K DRILL DIA. (in.)	L (in.)	T THREAD UNC-2B	MOUNTING HARDWARE SHCS	Dynamic Pressure (x 1,000 PSI)		
O-RING FACE	FLAT FACE												SX	SS ¹	
NPTF PORT / CODE 61 BLOCK FLANGE OR PAD															
8GQ1B	8GQ1P	1/2 - 14	0.50	1.81	2.13	0.50	0.63	1.25	0.344	1.42	5/16-18	5/16-18 x 1.25	5.0		
12GQ1B	12GQ1P	3/4 - 14	0.75	1.97	2.56	0.75	0.71	1.54	0.406	1.42	3/8-16	3/8-16 x 1.50	4.5		
16GQ1B	16GQ1P	1 - 11 1/2	1.00	2.17	2.75	1.00	0.71	1.81	0.406	1.50	3/8-16	3/8-16 x 1.50	4.0		
20GQ1B	20GQ1P	1 1/4 - 11 1/2	1.25	2.68	3.12	1.25	0.83	2.22	0.469	1.61	7/16-14	7/16-14 x 1.75	3.5		
24GQ1B	24GQ1P	1 1/2 - 11 1/2	1.50	3.07	3.66	1.50	0.98	2.50	0.531	1.77	1/2-13	1/2-13 x 1.75	2.7		
32GQ1B	32GQ1P	2 - 11 1/2	2.00	3.54	4.00	2.00	0.98	3.12	0.531	1.77	1/2-13	1/2-13 x 1.75	2.2		
40GQ1B	40GQ1P	2 1/2 - 8	2.50	4.09	4.49	2.50	0.98	3.62	0.531	1.97	1/2-13	1/2-13 x 1.75	2.0		
48GQ1B	48GQ1P	3 1/2 - 8	3.00	4.88	5.28	3.00	1.06	4.47	0.656	1.97	5/8-11	5/8-11 x 2.00	1.1		
NPTF PORT / CODE 62 BLOCK FLANGE OR PAD															
8GQ2B	8GQ2P	1/2 - 14	0.50	1.81	2.21	0.50	0.63	1.33	0.344	1.42	5/16-18	5/16-18 x 1.25	6.0		
12GQ2B	12GQ2P	3/4 - 14	0.75	2.17	2.80	0.75	0.83	1.65	0.406	1.38	3/8-16	3/8-16 x 1.50	5.0		
16GQ2B	16GQ2P	1 - 11 1/2	1.00	2.56	3.19	1.00	0.98	1.98	0.469	1.65	7/16-14	7/16-14 x 1.75	4.0		
20GQ2B	20GQ2P	1 1/4 - 11 1/2	1.25	3.07	3.75	1.25	1.06	2.36	0.531	1.77	1/2-13	1/2-13 x 1.75	3.5		
24GQ2B	24GQ2P	1 1/2 - 11 1/2	1.50	3.70	4.41	1.50	1.18	2.68	0.656	1.97	5/8-11	5/8-11 x 2.25	3.0		
32GQ2B	32GQ2P	2 - 11 1/2	2.00	4.50	5.28	2.00	1.46	3.38	0.781	2.56	3/4-10	3/4-10 x 2.75	2.5		

1) See page L38 for standard stainless steel sizes and dimensions.

To receive mounting hardware with flange, insert a "K" after the material designator. Mounting hardware kits are available for O-ring Face part numbers and include 4 bolts, 4 lock washers and an O-ring.

Dimensions and pressures for reference only, subject to change.



G4Q

BSPP Port Block Adapter
BSPP Port / Code 61 or 62
Block Flange or Pad

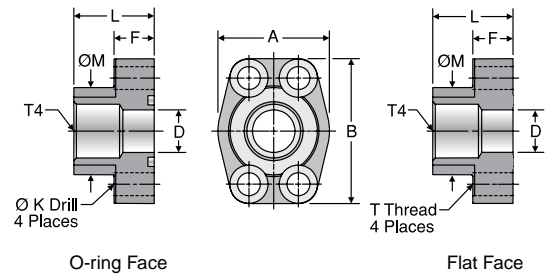

TUBE FITTING PART #		T4 THREAD	FLANGE SIZE (in.)	A (in.)	B (in.)	D (in.)	F (in.)	K DRILL DIA. (in.)	L (in.)	M (in.)	T THREAD	MOUNTING HARDWARE	Dynamic Pressure (x 1,000 PSI)	
O-RING FACE	FLAT FACE												SHCS	SX
BSPP PORT / CODE 61 BLOCK FLANGE OR PAD														
8G4Q1B	8G4Q1P	1/2-14	0.50	1.81	2.13	0.500	0.63	0.344	1.42	1.25	5/16-18	5/16-18 x 1.25	5.0	
12G4Q1B	12G4Q1P	3/4-14	0.75	1.97	2.56	0.750	0.71	0.406	1.42	1.54	3/8-16	3/8-16 x 1.50	4.0	
16G4Q1B	16G4Q1P	1-11	1.00	2.17	2.75	1.000	0.71	0.406	1.50	1.81	3/8-16	3/8-16 x 1.50	3.0	
20G4Q1B	20G4Q1P	1 1/4-11	1.25	2.68	3.12	1.250	0.83	0.469	1.61	2.22	7/16-14	7/16-14 x 1.75	2.5	
24G4Q1B	24G4Q1P	1 1/2-11	1.50	3.07	3.66	1.500	0.98	0.531	1.77	2.50	1/2-13	1/2-13 x 1.75	2.2	
32G4Q1B	32G4Q1P	2-11	2.00	3.54	4.00	2.000	0.98	0.531	1.77	3.12	1/2-13	1/2-13 x 1.75	1.7	
BSPP PORT / CODE 62 BLOCK FLANGE OR PAD														
8G4Q2B	8G4Q2P	1/2-14	0.50	1.81	2.21	0.500	0.63	0.344	1.42	1.33	5/16-18	5/16-18 x 1.25	6.0	
12G4Q2B	12G4Q2P	3/4-14	0.75	2.17	2.80	0.750	0.83	0.406	1.38	1.65	3/8-16	3/8-16 x 1.50	5.0	
16G4Q2B	16G4Q2P	1-11	1.00	2.56	3.19	1.000	0.98	0.469	1.65	1.98	7/16-14	7/16-14 x 1.75	4.0	
20G4Q2B	20G4Q2P	1 1/4-11	1.25	3.07	3.75	1.250	1.06	0.531	1.77	2.36	1/2-13	1/2-13 x 1.75	3.0	
24G4Q2B	24G4Q2P	1 1/2-11	1.50	3.70	4.41	1.500	1.18	0.656	1.97	2.68	5/8-11	5/8-11 x 2.25	2.5	
32G4Q2B	32G4Q2P	2-11	2.00	4.50	5.28	2.000	1.46	0.781	2.56	3.35	3/4-10	3/4-10 x 2.75	2.0	

To receive mounting hardware with flange, insert a "K" after the material designator. Mounting hardware kits are available for O-ring Face part numbers and include 4 bolts, 4 lock washers and an O-ring.

Dimensions and pressures for reference only, subject to change.



W5Q

Flat Weld Socket Block Connector, Pipe
Flat Weld Socket, Pipe / Code 61 or 62
Block Flange or Pad

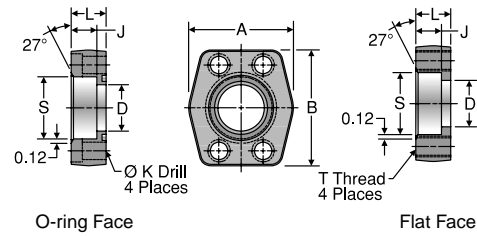

TUBE FITTING PART #		PIPE SIZE (in.)	FLANGE SIZE (in.)	A (in.)	B (in.)	D (in.)	J (in.)	K DRILL DIA. (in.)	L (in.)	S (in.)	T THREAD UNC-2B	MOUNTING HARDWARE		Dynamic Pressure (x 1,000 PSI)	
O-RING FACE	FLAT FACE											SHCS	SS ¹		
FLAT WELD SOCKET, PIPE / CODE 61 BLOCK FLANGE OR PAD															
8W5Q1B	8W5Q1P	1/2	0.50	1.813	2.125	0.500	0.560	0.344	0.750	0.855	5/16-18	5/16-18 x 1.50	5.0		
12W5Q1B	12W5Q1P	3/4	0.75	2.063	2.563	0.750	0.560	0.406	0.750	1.062	3/8-16	3/8-16 x 1.50	5.0		
16W5Q1B	16W5Q1P	1	1.00	2.313	2.750	1.000	0.630	0.406	0.880	1.326	3/8-16	3/8-16 x 1.75	5.0		
20W5Q1B	20W5Q1P	1 1/4	1.25	2.875	3.125	1.250	0.690	0.469	0.940	1.672	7/16-14	7/16-14 x 1.75	4.0		
24W5Q1B	24W5Q1P	1 1/2	1.50	3.250	3.688	1.500	0.750	0.531	1.190	1.922	1/2-13	1/2-13 x 2.25	3.0		
32W5Q1B	32W5Q1P	2	2.00	3.813	4.000	2.000	0.875	0.531	1.380	2.406	1/2-13	1/2-13 x 2.50	3.0		
40W5Q1B	40W5Q1P	2 1/2	2.50	4.281	4.500	2.500	1.000	0.531	1.750	2.906	1/2-13	1/2-13 x 2.75	2.5		
48W5Q1B	48W5Q1P	3	3.00	5.156	5.313	3.000	1.250	0.656	2.120	3.547	5/8-11	5/8-11 x 3.50	2.0		
56W5Q1B	56W5Q1P	3 1/2	3.50	5.500	6.000	3.500	1.190	0.656	1.440	4.047	5/8-11	5/8-11 x 2.75	0.5		
64W5Q1B	64W5Q1P	4	4.00	6.000	6.380	4.000	1.250	0.656	1.500	4.578	5/8-11	5/8-11 x 2.75	0.5		
80W5Q1B	80W5Q1P	5	5.00	7.120	7.250	4.500	1.380	0.656	1.750	5.641	5/8-11	5/8-11 x 3.00	0.5		
FLAT WELD SOCKET, PIPE / CODE 62 BLOCK FLANGE OR PAD															
8W5Q2B	8W5Q2P	1/2	0.50	1.940	2.300	0.500	0.560	0.344	1.250	0.855	5/16-18	5/16-18 x 2.00	6.0		
12W5Q2B	12W5Q2P	3/4	0.75	2.500	2.950	0.750	0.560	0.406	1.250	1.062	3/8-16	3/8-16 x 2.00	6.0		
16W5Q2B	16W5Q2P	1	1.00	2.750	3.190	1.000	0.630	0.469	1.500	1.326	7/16-14	7/16-14 x 2.50	6.0		
20W5Q2B	20W5Q2P	1 1/4	1.25	3.060	3.750	1.250	0.690	0.531	1.500	1.672	1/2-13	1/2-13 x 2.50	6.0		
24W5Q2B	24W5Q2P	1 1/2	1.50	3.750	4.440	1.500	0.750	0.656	1.750	1.922	5/8-11	5/8-11 x 3.00	6.0		
32W5Q2B	32W5Q2P	2	2.00	4.500	5.250	2.000	0.875	0.781	1.750	2.406	3/4-10	3/4-10 x 3.00	6.0		
40W5Q2B ²	40W5Q2P ²	2 1/2	2.50	5.870	6.870	2.500	1.000	0.906	2.060	2.906	7/8-9	7/8-9 x 3.50	6.0		
48W5Q2B ²	48W5Q2P ²	3	3.00	7.000	8.500	3.000	1.250	1.156	2.620	3.547	1 1/8-7	1 1/8-7 x 4.50	6.0		

1) See page L39 for standard stainless steel sizes and dimensions.
 2) Not covered in SAE J518. Bolt hole centerline dimensions are: 2.312" x 4.875" for 40W5Q2 and 2.812" x 6.000" for 48W5Q2.
 To receive mounting hardware with flange, insert a "K" after the material designator. Mounting hardware kits are available for O-ring Face part numbers and include 4 bolts, 4 lock washers and an O-ring.

Dimensions and pressures for reference only, subject to change.



W4Q

Flat Weld Socket Block Connector, Tube
Flat Weld Socket, Tube / Code 61 or 62
Block Flange or Pad

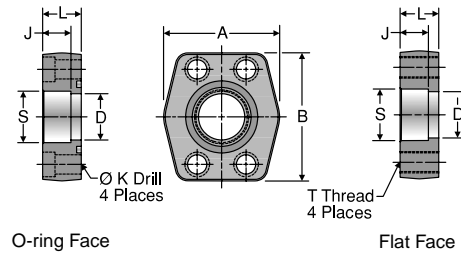

TUBE FITTING PART #		TUBE O.D. (in.)	FLANGE SIZE (in.)	A (in.)	B (in.)	D (in.)	J (in.)	K DRILL DIA. (in.)	L (in.)	S (in.)	T THREAD UNC-2B	MOUNTING HARDWARE SHCS	Dynamic Pressure (x 1,000 PSI)	
O-RING FACE	FLAT FACE												SX	SS
FLAT WELD SOCKET, TUBE / CODE 61 BLOCK FLANGE OR PAD														
12W4Q1B	12W4Q1P	3/4	0.75	2.06	2.56	0.625	0.560	0.406	0.750	0.752	3/8-16	3/8-16 x 1.50	5.0	
16-12W4Q1B	16-12W4Q1P	1	0.75	2.06	2.56	0.750	0.560	0.406	0.750	1.002	3/8-16	3/8-16 x 1.50	5.0	
16W4Q1B	16W4Q1P	1	1.00	2.31	2.75	0.875	0.630	0.406	0.880	1.002	3/8-16	3/8-16 x 1.75	5.0	
20-16W4Q1B	20-16W4Q1P	1 1/4	1.00	2.31	2.75	1.000	0.630	0.406	0.880	1.252	3/8-16	3/8-16 x 1.75	5.0	
20W4Q1B	20W4Q1P	1 1/4	1.25	2.88	3.12	1.125	0.690	0.469	0.940	1.252	7/16-14	7/16-14 x 1.75	4.0	
24-20W4Q1B	24-20W4Q1P	1 1/2	1.25	2.88	3.12	1.250	0.690	0.469	0.940	1.502	7/16-14	7/16-14 x 1.75	4.0	
24W4Q1B	24W4Q1P	1 1/2	1.50	3.25	3.69	1.375	0.750	0.531	1.190	1.502	1/2-13	1/2-13 x 2.25	3.0	
28-24W4Q1B	28-24W4Q1P	1 3/4	1.50	3.25	3.69	1.500	0.750	0.531	1.190	1.752	1/2-13	1/2-13 x 2.25	3.0	
32W4Q1B	32W4Q1P	2	2.00	3.81	4.00	1.875	0.875	0.531	1.375	2.002	1/2-13	1/2-13 x 2.50	3.0	
36-32W4Q1B	36-32W4Q1P	2 1/4	2.00	3.81	4.00	2.000	0.875	0.531	1.375	2.252	1/2-13	1/2-13 x 2.50	3.0	
FLAT WELD SOCKET, TUBE / CODE 62 BLOCK FLANGE OR PAD														
12W4Q2B	12W4Q2P	3/4	0.75	2.38	2.81	0.625	0.560	0.406	1.250	0.752	3/8-16	3/8-16 x 2.00	6.0	
16-12W4Q2B	16-12W4Q2P	1	0.75	2.38	2.81	0.750	0.560	0.406	1.250	1.002	3/8-16	3/8-16 x 2.00	6.0	
16W4Q2B	16W4Q2P	1	1.00	2.75	3.19	0.875	0.630	0.469	1.500	1.002	7/16-14	7/16-14 x 2.25	6.0	
20-16W4Q2B	20-16W4Q2P	1 1/4	1.00	2.75	3.19	1.000	0.630	0.469	1.500	1.252	7/16-14	7/16-14 x 2.25	6.0	
20W4Q2B	20W4Q2P	1 1/4	1.25	3.06	3.75	1.125	0.690	0.531	1.500	1.252	1/2-13	1/2-13 x 2.50	6.0	
24-20W4Q2B	24-20W4Q2P	1 1/5	1.25	3.06	3.75	1.250	0.690	0.531	1.500	1.502	1/2-13	1/2-13 x 2.50	6.0	
24W4Q2B	24W4Q2P	1 1/2	1.50	3.75	4.44	1.375	0.750	0.656	1.750	1.502	5/8-11	5/8-11 x 2.75	6.0	
28-24W4Q2B	28-24W4Q2P	1 3/4	1.50	3.75	4.44	1.500	0.750	0.656	1.750	1.752	5/8-11	5/8-11 x 2.75	6.0	
32W4Q2B1 ¹	32W4Q2P1 ¹	2	2.00	4.50	5.25	1.875	0.875	0.781	1.750	2.002	3/4-10	3/4-10 x 3.00	6.0	
36-32W4Q2B1 ¹	36-32W4Q2P1 ¹	2 1/4	2.00	4.50	5.25	2.000	0.875	0.781	1.750	2.252	3/4-10	3/4-10 x 3.00	6.0	

1) Not covered in SAE J518.

To receive mounting hardware with flange, insert a "K" after the material designator. Mounting hardware kits are available for O-ring Face part numbers and include 4 bolts, 4 lock washers and an O-ring.

Dimensions and pressures for reference only, subject to change.



W7Q

Extended Weld Socket Block Connector, Pipe
Deep Weld Socket, Pipe / Code 61 or 62
Block Flange or Pad

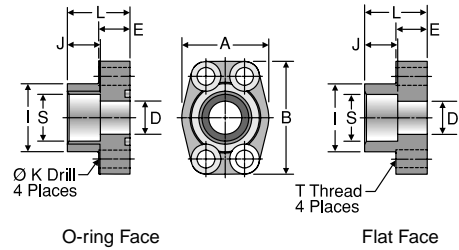

TUBE FITTING PART #		PIPE SIZE (in.)	FLANGE SIZE (in.)	A (in.)	B (in.)	D (in.)	E (in.)	I (in.)	J (in.)	K DRILL DIA. (in.)	L (in.)	S (in.)	T THREAD UNC-2B	MOUNTING HARDWARE SHCS	Dynamic Pressure (x 1,000 PSI)	
O-RING FACE	FLAT FACE														SX	SS
EXTENDED WELD SOCKET, PIPE / CODE 61 BLOCK FLANGE OR PAD																
12W7Q1B	12W7Q1P	3/4	0.75	1.97	2.56	0.75	0.710	1.54	0.750	0.406	1.420	1.062	3/8-16	3/8-16 x 1.50	5.0	
16W7Q1B	16W7Q1P	1	1.00	2.17	2.75	1.00	0.710	1.81	0.750	0.406	1.500	1.328	3/8-16	3/8-16 x 1.50	4.5	
20W7Q1B	20W7Q1P	1 1/4	1.25	2.68	3.12	1.25	0.830	2.22	0.870	0.469	1.610	1.672	7/16-14	7/16-14 x 1.75	2.7	
24W7Q1B	24W7Q1P	1 1/2	1.50	3.07	3.66	1.50	0.980	2.50	0.940	0.531	1.770	1.922	1/2-13	1/2-13 x 1.75	3.0	
32W7Q1B	32W7Q1P	2	2.00	3.54	4.00	2.00	0.980	3.12	1.020	0.531	1.770	2.406	1/2-13	1/2-13 x 1.75	2.5	
40W7Q1B	40W7Q1P	2 1/2	2.50	4.09	4.49	2.50	0.980	3.62	1.180	0.531	1.970	2.906	1/2-13	1/2-13 x 1.75	2.2	
EXTENDED WELD SOCKET, PIPE / C ODE 62 BLOCK FLANGE OR PAD																
12W7Q2B	12W7Q2P	3/4	0.75	2.17	2.80	0.75	0.830	1.65	0.870	0.406	1.380	1.062	3/8-16	3/8-16 x 1.50	6.0	
16W7Q2B	16W7Q2P	1	1.00	2.56	3.19	1.00	0.980	1.98	0.870	0.469	1.650	1.328	7/16-14	7/16-14 x 1.75	6.0	
20W7Q2B	20W7Q2P	1 1/4	1.25	3.07	3.75	1.25	1.060	2.36	0.980	0.531	1.770	1.672	1/2-13	1/2-13 x 1.75	5.5	
24W7Q2B	24W7Q2P	1 1/2	1.50	3.7	4.41	1.50	1.180	2.68	1.100	0.656	1.970	1.922	5/8-11	5/8-11 x 2.25	5.5	
32W7Q2B	32W7Q2P	2	2.00	4.5	5.28	2.00	1.460	3.35	0.940	0.781	2.560	2.406	3/4-10	3/4-10 x 2.75	5.0	

To receive mounting hardware with flange, insert a "K" after the material designator. Mounting hardware kits are available for O-ring Face part numbers and include 4 bolts, 4 lock washers and an O-ring.

Dimensions and pressures for reference only, subject to change.



W6Q

Extended Weld Socket Block Connector, Tube
Deep Weld Socket, Tube / Code 61 or 62
Block Flange or Pad

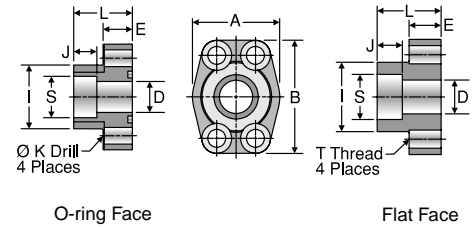

TUBE FITTING PART #		TUBE O.D. (in.)	FLANGE SIZE (in.)	A (in.)	B (in.)	D (in.)	E (in.)	I (in.)	J (in.)	K DRILL DIA. (in.)	L (in.)	S (in.)	T THREAD UNC-2B	MOUNTING HARDWARE SHCS	Dynamic Pressure (x 1,000 PSI)	
O-RING FACE	FLAT FACE														SX	SS
EXTENDED WELD SOCKET, TUBE / CODE 61 BLOCK FLANGE OR PAD																
12W6Q1B	12W6Q1P	3/4	0.75	1.97	2.56	0.625	0.71	1.54	0.560	0.406	1.420	0.752	3/8-16	3/8-16 x 1.50	5.0	
16-12W6Q1B	16-12W6Q1P	1	0.75	1.97	2.56	0.750	0.71	1.54	0.560	0.406	1.420	1.002	3/8-16	3/8-16 x 1.50	5.0	
16W6Q1B	16W6Q1P	1	1.00	2.17	2.75	0.875	0.71	1.81	0.630	0.406	1.500	1.002	3/8-16	3/8-16 x 1.50	5.0	
20-16W6Q1B	20-16W6Q1P	1 1/4	1.00	2.17	2.75	1.000	0.71	1.81	0.630	0.406	1.500	1.252	3/8-16	3/8-16 x 1.50	5.0	
20W6Q1B	20W6Q1P	1 1/4	1.25	2.68	3.12	1.125	0.83	2.22	0.690	0.469	1.610	1.252	7/16-14	7/16-14 x 1.75	4.0	
24-20W6Q1B	24-20W6Q1P	1 1/2	1.25	2.68	3.12	1.250	0.83	2.22	0.690	0.469	1.610	1.502	7/16-14	7/16-14 x 1.75	4.0	
24W6Q1B	24W6Q1P	1 1/2	1.50	3.07	3.66	1.375	0.98	2.50	0.750	0.531	1.770	1.502	1/2-13	1/2-13 x 1.75	3.0	
28-24W6Q1B	28-24W6Q1P	1 3/4	1.50	3.07	3.66	1.500	0.98	2.50	0.750	0.531	1.770	1.752	1/2-13	1/2-13 x 1.75	3.0	
32W6Q1B	32W6Q1P	2	2.00	3.54	4.00	1.875	0.98	3.12	0.870	0.531	1.770	2.002	1/2-13	1/2-13 x 1.75	3.0	
36-32W6Q1B	36-32W6Q1P	2 1/4	2.00	3.54	4.00	2.000	0.98	3.12	0.870	0.531	1.770	2.252	1/2-13	1/2-13 x 1.75	3.0	
40W6Q1B	40W6Q1P	2 1/2	2.50	4.09	4.49	2.375	0.98	3.62	1.000	0.531	1.970	2.502	1/2-13	1/2-13 x 1.75	2.5	
44-40W6Q1B	44-40W6Q1P	2 3/4	2.50	4.09	4.49	2.500	0.98	3.62	1.000	0.531	1.970	2.752	1/2-13	1/2-13 x 1.75	2.2	
EXTENDED WELD SOCKET, TUBE / CODE 62 BLOCK FLANGE OR PAD																
12W6Q2B	12W6Q2P	3/4	0.75	2.17	2.80	0.625	0.83	1.65	0.560	0.406	1.380	0.752	3/8-16	3/8-16 x 1.50	6.0	
16-12W6Q2B	16-12W6Q2P	1	0.75	2.17	2.80	0.750	0.83	1.65	0.560	0.406	1.380	1.002	3/8-16	3/8-16 x 1.50	6.0	
16W6Q2B	16W6Q2P	1	1.00	2.56	3.19	0.875	0.98	1.98	0.630	0.469	1.650	1.002	7/16-14	7/16-14 x 1.75	6.0	
20-16W6Q2B	20-16W6Q2P	1 1/4	1.00	2.56	3.19	1.000	0.98	1.98	0.630	0.469	1.650	1.252	7/16-14	7/16-14 x 1.75	6.0	
20W6Q2B	20W6Q2P	1 1/4	1.25	3.07	3.75	1.125	1.06	2.36	0.690	0.531	1.770	1.252	1/2-13	1/2-13 x 1.75	6.0	
24-20W6Q2B	24-20W6Q2P	1 1/2	1.25	3.07	3.75	1.250	1.06	2.36	0.690	0.531	1.770	1.502	1/2-13	1/2-13 x 1.75	6.0	
24W6Q2B	24W6Q2P	1 1/2	1.50	3.70	4.41	1.375	1.18	2.68	0.750	0.656	1.970	1.502	5/8-11	5/8-11 x 2.25	6.0	
28-24W6Q2B	28-24W6Q2P	1 3/4	1.50	3.70	4.41	1.500	1.18	2.68	0.750	0.656	1.970	1.752	5/8-11	5/8-11 x 2.25	6.0	
32W6Q2B	32W6Q2P	2	2.00	4.50	5.28	1.875	1.46	3.35	0.870	0.781	2.560	2.002	3/4-10	3/4-10 x 2.75	6.0	
36-32W6Q2B	36-32W6Q2P	2 1/4	2.00	4.50	5.28	2.000	1.46	3.35	0.870	0.781	2.560	2.252	3/4-10	3/4-10 x 2.75	5.5	

To receive mounting hardware with flange, insert a "K" after the material designator. Mounting hardware kits are available for O-ring Face part numbers and include 4 bolts, 4 lock washers and an O-ring.

Dimensions and pressures for reference only, subject to change.



WB1Q1 / WB3Q1 / WB5Q1

Code 61 Weld Butt Block Connector, Pipe
Schedule 40, 80 or 160 Weld Butt /
Code 61 Block Flange or Pad

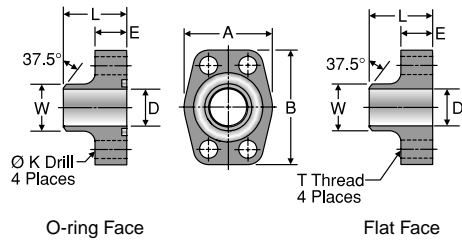

WELD BUTT BLOCK CONNECTION TYPE	TUBE FITTING PART #		PIPE SIZE (in.)	FLANGE SIZE (in.)	A (in.)	B (in.)	D PIPE I.D. (in.)	E (in.)	K DRILL DIA. (in.)	L (in.)	T THREAD UNC-2B	W PIPE O.D. (in.)	MOUNTING HARDWARE SHCS		Dynamic Pressure (x 1,000 PSI)	
	O-RING FACE	FLAT FACE											SX	SS		
SCHEDULE 40 WELD BUTT / CODE 61 BLOCK FLANGE OR PAD																
WB1Q1 For Schedule 40 pipe	12WB1Q1B	12WB1Q1P	3/4	0.75	1.97	2.56	0.826	0.710	0.406	1.420	3/8-16	1.050	3/8-16 x 1.50	3.5		
	16WB1Q1B	16WB1Q1P	1	1.00	2.17	2.75	1.051	0.710	0.406	1.500	3/8-16	1.315	3/8-16 x 1.50	3.0		
	20WB1Q1B	20WB1Q1P	1 1/4	1.25	2.68	3.12	1.382	0.830	0.469	1.610	7/16-14	1.660	7/16-14 x 1.75	2.7		
	24WB1Q1B	24WB1Q1P	1 1/2	1.50	3.07	3.66	1.612	0.980	0.531	1.730	1/2-13	1.900	1/2-13 x 1.75	2.2		
	32WB1Q1B	32WB1Q1P	2	2.00	3.54	4.00	2.069	0.980	0.531	1.770	1/2-13	2.375	1/2-13 x 1.75	2.0		
	40WB1Q1B	40WB1Q1P	2 1/2	2.50	4.09	4.49	2.471	0.980	0.531	1.970	1/2-13	2.875	1/2-13 x 1.75	2.0		
	48WB1Q1B	48WB1Q1P	3	3.00	4.88	5.28	3.070	1.060	0.656	1.970	5/8-11	3.500	5/8-11 x 2.00	1.7		
SCHEDULE 80 WELD BUTT / CODE 61 BLOCK FLANGE OR PAD																
WB3Q1 For Schedule 80 pipe	12WB3Q1B	12WB3Q1P	3/4	0.75	1.97	2.56	0.744	0.710	0.406	1.420	3/8-16	1.050	3/8-16 x 1.50	5.0		
	16WB3Q1B	16WB3Q1P	1	1.00	2.17	2.75	0.959	0.710	0.406	1.500	3/8-16	1.315	3/8-16 x 1.50	4.5		
	20WB3Q1B	20WB3Q1P	1 1/4	1.25	2.68	3.12	1.280	0.830	0.469	1.610	7/16-14	1.660	7/16-14 x 1.75	4.0		
	24WB3Q1B	24WB3Q1P	1 1/2	1.50	3.07	3.66	1.502	0.980	0.531	1.730	1/2-13	1.900	1/2-13 x 1.75	3.0		
	32WB3Q1B	32WB3Q1P	2	2.00	3.54	4.00	1.941	0.980	0.531	1.770	1/2-13	2.375	1/2-13 x 1.75	3.0		
	40WB3Q1B	40WB3Q1P	2 1/2	2.50	4.09	4.49	2.325	0.980	0.531	1.970	1/2-13	2.875	1/2-13 x 1.75	2.5		
	48WB3Q1B	48WB3Q1P	3	3.00	4.88	5.28	2.902	1.060	0.656	1.970	5/8-11	3.500	5/8-11 x 2.00	2.0		
SCHEDULE 160 WELD BUTT / CODE 61 BLOCK FLANGE OR PAD																
WB5Q1 For Schedule 160 pipe	12WB5Q1B	12WB5Q1P	3/4	0.75	1.97	2.56	0.614	0.710	0.406	1.420	3/8-16	1.050	3/8-16 x 1.50	5.0		
	16WB5Q1B	16WB5Q1P	1	1.00	2.17	2.75	0.817	0.710	0.406	1.500	3/8-16	1.315	3/8-16 x 1.50	5.0		
	20WB5Q1B	20WB5Q1P	1 1/4	1.25	2.68	3.12	1.162	0.830	0.469	1.610	7/16-14	1.660	7/16-14 x 1.75	4.0		
	24WB5Q1B	24WB5Q1P	1 1/2	1.50	3.07	3.66	1.340	0.980	0.531	1.730	1/2-13	1.900	1/2-13 x 1.75	3.0		
	32WB5Q1B	32WB5Q1P	2	2.00	3.54	4.00	1.689	0.980	0.531	1.770	1/2-13	2.375	1/2-13 x 1.75	3.0		
	40WB5Q1B	40WB5Q1P	2 1/2	2.50	4.09	4.49	2.127	0.980	0.531	1.970	1/2-13	2.875	1/2-13 x 1.75	2.5		
	48WB5Q1B	48WB5Q1P	3	3.00	4.88	5.28	2.626	1.060	0.656	1.970	5/8-11	3.500	5/8-11 x 2.00	2.0		

To receive mounting hardware with flange, insert a "K" after the material designator. Mounting hardware kits are available for O-ring Face part numbers and include 4 bolts, 4 lock washers and an O-ring.

Dimensions and pressures for reference only, subject to change.

WB3Q2 / WB5Q2 / WB7Q2

Code 62 Weld Butt Block Connector, Pipe
Schedule 80, 160 or XXS Weld Butt /
Code 62 Block Flange or Pad

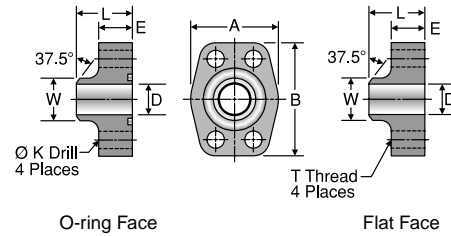

WELD BUTT CONNECTION TYPE	TUBE FITTING PART #		PIPE SIZE (in.)	FLANGE SIZE (in.)	A (in.)	B (in.)	D PIPE I.D. (in.)	E (in.)	K DRILL DIA. (in.)	L (in.)	T THREAD UNC-2B	W PIPE O.D. (in.)	MOUNTING HARDWARE SHCS	Dynamic Pressure (x 1,000 PSI)	
	O-RING FACE	FLAT FACE												SX	SS
SCHEDULE 80 WELD BUTT / CODE 62 BLOCK FLANGE OR PAD															
WB3Q2 For Schedule 80 pipe	12WB3Q2B	12WB3Q2P	3/4	0.75	2.17	2.80	0.744	0.83	0.406	1.38	3/8-16	1.050	3/8-16 x 1.50	5.0	
	16WB3Q2B	16WB3Q2P	1	1.00	2.56	3.19	0.959	0.83	0.469	1.61	7/16-14	1.315	7/16-14 x 1.75	4.5	
	20WB3Q2B	20WB3Q2P	1 1/4	1.25	3.07	3.75	1.280	0.98	0.531	1.73	1/2-13	1.660	1/2-13 x 1.75	3.5	
	24WB3Q2B	24WB3Q2P	1 1/2	1.50	3.70	4.41	1.502	1.18	0.656	2.17	5/8-11	1.900	5/8-11 x 2.25	3.0	
	32WB3Q2B	32WB3Q2P	2	2.00	4.50	5.28	1.941	1.46	0.781	2.56	3/4-10	2.375	3/4-10 x 2.75	3.0	
SCHEDULE 160 WELD BUTT / CODE 62 BLOCK FLANGE OR PAD															
WB5Q2 For Schedule 160 pipe	12WB5Q2B	12WB5Q2P	3/4	0.75	2.17	2.80	0.614	0.83	0.406	1.38	3/8-16	1.050	3/8-16 x 1.50	6.0	
	16WB5Q2B	16WB5Q2P	1	1.00	2.56	3.19	0.817	0.83	0.469	1.61	7/16-14	1.315	7/16-14 x 1.75	6.0	
	20WB5Q2B	20WB5Q2P	1 1/4	1.25	3.07	3.75	1.162	0.98	0.531	1.73	1/2-13	1.660	1/2-13 x 1.75	5.0	
	24WB5Q2B	24WB5Q2P	1 1/2	1.50	3.70	4.41	1.340	1.18	0.656	2.17	5/8-11	1.900	5/8-11 x 2.25	5.0	
	32WB5Q2B	32WB5Q2P	2	2.00	4.50	5.28	1.689	1.46	0.781	2.56	3/4-10	2.375	3/4-10 x 2.75	6.0	
SCHEDULE XXS WELD BUTT / CODE 62 BLOCK FLANGE OR PAD															
WB7Q2 For Schedule XXS pipe	12WB7Q2B	12WB7Q2P	3/4	0.75	2.17	2.80	0.436	0.83	0.406	1.38	3/8-16	1.050	3/8-16 x 1.50	6.0	
	16WB7Q2B	16WB7Q2P	1	1.00	2.56	3.19	0.601	0.83	0.469	1.61	7/16-14	1.315	7/16-14 x 1.75	6.0	
	20WB7Q2B	20WB7Q2P	1 1/4	1.25	3.07	3.75	0.898	0.98	0.531	1.73	1/2-13	1.660	1/2-13 x 1.75	6.0	
	24WB7Q2B	24WB7Q2P	1 1/2	1.50	3.70	4.41	1.102	1.18	0.656	2.17	5/8-11	1.900	5/8-11 x 2.25	6.0	
	32WB7Q2B	32WB7Q2P	2	2.00	4.50	5.28	1.505	1.46	0.781	2.56	3/4-10	2.375	3/4-10 x 2.75	6.0	

1) SAE J518 does not cover these sizes in Code 62.

To receive mounting hardware with flange, insert a "K" after the material designator. Mounting hardware kits are available for O-ring Face part numbers and include 4 bolts, 4 lock washers and an O-ring.

Dimensions and pressures for reference only, subject to change.



AS3 / AS6

SAE-Flange / Weld Butt

For metric tube welded connection

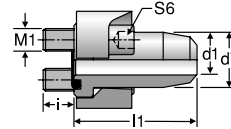

TUBE FITTING PART #	SIZE (in.)	TUBE O.D. x WALL THICKNESS (mm)	WORKING PRESSURE (bar)	d1 (mm)	d7 (mm)	l (mm)	l1 (mm)	S6 (mm)	WELD NIPPLE BODY	FROM STOCK CF	71
SAE FLANGE CONNECTION – CODE 61 – STANDARD SERIES											
AS32/15X2	1/2	15 x 2	200	11	23.9	11.5	38	6	AS32/15X2X		
AS32/16X3	1/2	16 x 3	220	10	23.9	11.5	38	6	AS32/16X3X		
AS33/18X1.5	3/4	18 x 1.5	130	15	31.8	15.5	50	8	AS33/18X1.5X		
AS33/22X2	3/4	22 x 2	140	18	31.8	15.5	50	8	AS33/22X2X		
AS33/20X3	3/4	20 x 3	220	14	31.8	15.5	50	8	AS33/20X3X		
AS33/25X4	3/4	25 x 4	220	17	31.8	15.5	50	8	AS33/25X4X		
AS34/28X2	1	28 x 2	115	24	38	13.5	50	8	AS34/28X2X		
AS34/30X4.5	1	30 x 4.5	220	21	38	13.5	50	8	AS34/30X4.5X		
AS35/35X2	1 1/4	35 x 2	90	31	43	18.5	55	8	AS35/35X2X		
AS35/25X3	1 1/4	25 x 3	175	19	43	18.5	55	8	AS35/25X3X		
AS35/30X4	1 1/4	30 x 4	175	22	43	18.5	55	8	AS35/30X4X		
AS35/38X5	1 1/4	38 x 5	175	28	43	18.5	55	8	AS35/38X5X		
AS36/42X3	1 1/2	42 x 3	115	36	50	18.5	57	10	AS36/42X3X		
AS36/38X4	1 1/2	38 x 4	130	30	50	18.5	57	10	AS36/38X4X		
AS38/50X6	2	50 x 6	130	38	62	24	62	12	AS38/50X6X		
AS38/65X8	2	65 x 8	130	49	65	24	62	12	AS38/65X8X		
SAE FLANGE CONNECTION – CODE 62 – HIGH PRESSURE SERIES											
AS62/16X3	1/2	16 x 3	260	10	23.9	13.5	41	6	AS62/16X3X		
AS63/25X5	3/4	25 x 5	260	15	31.8	15.5	55	8	AS63/25X5X		
AS64/25X5	1	25 x 5	260	15	38	20.5	67	10	AS64/25X5X		
AS64/30X4	1	30 x 4	200	22	38	20.5	67	10	AS64/30X4X		
AS65/30X4*	1 1/4	30 x 4	200	22	43.7	17.5	78	10	AS65/30X4X		
AS65/38X5	1 1/4	38 x 5	200	28	43.7	17.5	78	10	AS65/38X5X		
AS65/38X8*	1 1/4	38 x 8	260	22	43.7	17.5	78	10	AS65/38X8X		
AS66/38X5	1 1/2	38 x 5	200	28	50.8	24.5	85	14	AS66/38X5X		
AS66/38X8	1 1/2	38 x 8	260	22	50.8	24.5	85	14	AS66/38X8X		
AS68/50X9	2	50 x 9	260	32	66.6	32.5	116	17	AS68/50X9X		
AS68/65X9	2	65 x 8	190	49	66.6	32.5	116	17	AS68/65X8X		

* Identical types.

Temperature range without pressure reductions for fittings with O-ring sealing of NBR (e.g., buna N series) -35°C up to +100°C, FPM (e.g., fluorocarbon on request) -25°C up to +120°C.

Tightening torques for socket head cap screws see Tables S6 and S7.

WBT

Code 61 Weld Butt Tank Adapter

Weld Butt with Pilot / Code 61 Block Flange Pad

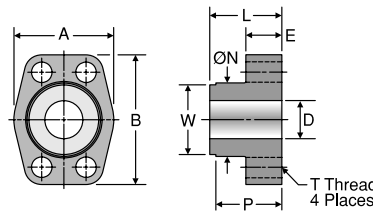

TUBE FITTING PART #	FLANGE SIZE (in.)	A (in.)	B (in.)	D (in.)	E (in.)	L (in.)	P (in.)	T THREAD UNC-2B	W (in.)	Dynamic Pressure (x 1,000 PSI)	
										S	SS
12WBTQ1P	0.75	1.97	2.56	0.75	0.71	1.42	1.30	3/8-16	1.375	0.5	
16WBTQ1P	1.00	2.17	2.75	1.00	0.71	1.50	1.37	3/8-16	1.500	0.5	
20WBTQ1P	1.25	2.68	3.12	1.25	0.83	1.61	1.49	7/16-14	1.750	0.5	
24WBTQ1P	1.50	3.07	3.66	1.50	0.98	1.77	1.64	1/2-13	2.125	0.5	
32WBTQ1P	2.00	3.54	4.00	2.00	0.98	1.77	1.65	1/2-13	2.500	0.5	
40WBTQ1P	2.50	4.09	4.50	2.50	0.98	1.97	1.85	1/2-13	3.250	0.5	

Dimensions and pressures for reference only, subject to change.

WSD

Code 61 Weld Saddle Block Connector
Pipe or Tube Weld Saddle /
Code 61 Block Flange or Pad

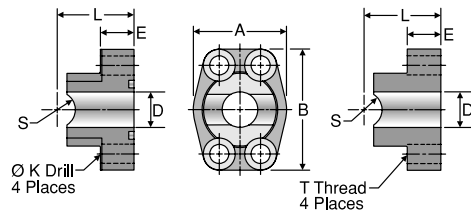

O-ring Face

Flat Face

TUBE FITTING PART #		PIPE OR TUBE SIZE (in.)	FLANGE SIZE (in.)	A (in.)	B (in.)	D (in.)	E (in.)	K DRILL DIA. (in.)	L (in.)	S (in.)	T THREAD UNC-2B	MOUNTING HARDWARE SHCS	Dynamic Pressure (x 1,000 PSI)	
O-RING FACE	FLAT FACE												SX	SS
PIPE WELD SADDLE / CODE 61 BLOCK FLANGE OR PAD														
12WSD1Q1B	12WSD1Q1P	3/4	0.75	1.97	2.56	0.75	0.710	0.406	1.42	0.532	3/8-16	3/8-16 x 1.50	5.0	
16WSD1Q1B	16WSD1Q1P	1	1.00	2.17	2.75	1.00	0.710	0.406	1.50	0.665	3/8-16	3/8-16 x 1.50	5.0	
20WSD1Q1B	20WSD1Q1P	1 1/4	1.25	2.68	3.12	1.25	0.830	0.469	1.61	0.837	7/16-14	7/16-14 x 1.75	4.0	
24WSD1Q1B	24WSD1Q1P	1 1/2	1.50	3.07	3.66	1.50	0.980	0.531	1.77	0.957	1/2-13	1/2-13 x 1.75	3.0	
32WSD1Q1B	32WSD1Q1P	2	2.00	3.54	4.00	2.00	0.980	0.531	1.77	1.200	1/2-13	1/2-13 x 1.75	3.0	
TUBE WELD SADDLE / CODE 61 BLOCK FLANGE OR PAD														
12WSD2Q1B	12WSD2Q1P	3/4	0.75	1.97	2.56	0.75	0.710	0.406	1.42	0.382	3/8-16	3/8-16 x 1.50	5.0	
16-12WSD2Q1B	16-12WSD2Q1P	1	0.75	1.97	2.56	0.75	0.710	0.406	1.42	0.507	3/8-16	3/8-16 x 1.50	5.0	
16WSD2Q1B	16WSD2Q1P	1	1.00	2.17	2.75	1.00	0.710	0.406	1.50	0.507	3/8-16	3/8-16 x 1.50	5.0	
20-16WSD2Q1B	20-16WSD2Q1P	1 1/4	1.00	2.17	2.75	1.00	0.710	0.406	1.50	0.632	3/8-16	3/8-16 x 1.50	5.0	
20WSD2Q1B	20WSD2Q1P	1 1/4	1.25	2.68	3.12	1.25	0.830	0.469	1.61	0.632	7/16-14	7/16-14 x 1.75	4.0	
24-20WSD2Q1B	24-20WSD2Q1P	1 1/2	1.25	2.68	3.12	1.25	0.830	0.469	1.61	0.757	7/16-14	7/16-14 x 1.75	4.0	
24WSD2Q1B	24WSD2Q1P	1 1/2	1.50	3.07	3.66	1.50	0.980	0.531	1.77	0.757	1/2-13	1/2-13 x 1.75	3.0	
28-24WSD2Q1B	28-24WSD2Q1P	1 3/4	1.50	3.07	3.66	1.50	0.980	0.531	1.77	0.882	1/2-13	1/2-13 x 1.75	3.0	
32WSD2Q1B	32WSD2Q1P	2	2.00	3.54	4.00	2.00	0.980	0.531	1.77	1.007	1/2-13	1/2-13 x 1.75	3.0	
36-32WSD2Q1B	36-32WSD2Q1P	2 1/4	2.00	3.54	4.00	2.00	0.980	0.531	1.77	1.132	1/2-13	1/2-13 x 1.75	3.0	

To receive mounting hardware with flange, insert a "K" after the material designator. Mounting hardware kits are available for O-ring Face part numbers and include 4 bolts, 4 lock washers and an O-ring.

GQS

NPTF Port Square Block Flange Adapter
NPTF Port / Square Block Flange or Pad

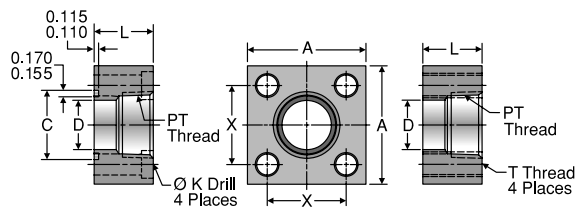

O-ring Face

Flat Face

TUBE FITTING PART #		PT THREAD NPTF	FLANGE SIZE (in.)	A (in.)	B (in.)	C MIN. (in.)	D (in.)	K DRILL DIA. (in.)	L (in.)	T THREAD UNC-2B	X (in.)	O-RING	MOUNTING HARDWARE SHCS	Dynamic Pressure (x 1,000 PSI)	
O-RING FACE	FLAT FACE													SX	SS
12GQSB	12GQSP	3/4-14	0.75	2.25	1.12	1.250	0.75	0.406	1.25	3/8-16	1.438	2-214	3/8-16 x 2.00	5.0	
16GQSB	16GQSP	1-11 1/2	1.00	3.00	1.50	1.560	1.00	0.531	1.50	1/2-13	2.000	2-219	1/2-13 x 2.25	5.0	
20GQSB	20GQSP	1 1/4-11 1/2	1.25	3.00	1.50	1.750	1.25	0.531	1.50	1/2-13	2.000	2-222	1/2-13 x 2.25	4.0	
24GQSB	24GQSP	1 1/2-11 1/2	1.50	4.00	2.00	2.115	1.50	0.656	1.75	5/8-11	2.750	2-225	5/8-11 x 2.75	3.0	
32GQSB	32GQSP	2-11 1/2	2.00	4.00	2.00	2.490	2.00	0.656	1.75	5/8-11	2.750	2-228	5/8-11 x 2.75	2.7	
40GQSB	40GQSP	2 1/2-8	2.50	5.50	2.75	2.995	2.50	0.906	2.25	7/8-9	3.750	2-232	7/8-9 x 3.50	2.5	
48GQSB	48GQSP	3-8	3.00	5.50	2.75	3.615	3.00	0.906	2.25	7/8-9	3.750	2-237	7/8-9 x 3.50	1.2	

To receive mounting hardware with flange, insert a "K" after the material designator. Mounting hardware kits are available for O-ring Face part numbers and include 4 bolts, 4 lock washers and an O-ring.

Dimensions and pressures for reference only, subject to change.



W5SQS

Weld Socket Square Block Connector, Pipe
Pipe Weld Socket / Square Block Flange or Pad

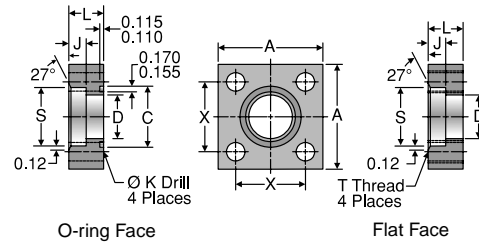

TUBE FITTING PART #		PIPE SIZE (in.)	FLANGE SIZE (in.)	A (in.)	B (in.)	C MIN. (in.)	D (in.)	J (in.)	K DRILL DIA. (in.)	L (in.)	S (in.)	T THREAD UNC-2B	X (in.)	O-RING	MOUNTING HARDWARE SHCS		Dynamic Pressure (x 1,000 PSI)	
O-RING FACE	FLAT FACE														SX	SS		
12W5SQSB	12W5SQSP	3/4	0.75	2.25	1.12	1.250	0.75	0.50	0.406	1.00	1.062	3/8-16	1.438	2-214	3/8-16 x 1.75	5.0		
16W5SQSB	16W5SQSP	1	1.00	3.00	1.50	1.560	1.00	0.50	0.531	1.00	1.328	1/2-13	2.000	2-219	1/2-13 x 1.75	5.0		
20W5SQSB	20W5SQSP	1 1/4	1.25	3.00	1.50	1.750	1.25	0.50	0.531	1.00	1.672	1/2-13	2.000	2-222	1/2-13 x 1.75	4.0		
24W5SQSB	24W5SQSP	1 1/2	1.50	4.00	2.00	2.115	1.50	0.62	0.656	1.25	1.922	5/8-11	2.750	2-225	5/8-11 x 2.25	3.0		
32W5SQSB	32W5SQSP	2	2.00	4.00	2.00	2.490	2.00	0.62	0.656	1.25	2.406	5/8-11	2.750	2-228	5/8-11 x 2.25	3.0		
40W5SQSB	40W5SQSP	2 1/2	2.50	5.50	2.75	2.995	2.50	0.75	0.906	1.50	2.906	7/8-9	3.750	2-232	7/8-9 x 2.75	2.5		
48W5SQSB	48W5SQSP	3	3.00	5.50	2.75	3.615	3.00	0.75	0.906	1.50	3.547	7/8-9	3.750	2-237	7/8-9 x 2.75	2.0		

To receive mounting hardware with flange, insert a "K" after the material designator. Mounting hardware kits are available for O-ring Face part numbers and include 4 bolts, 4 lock washers and an O-ring.

PQ

Block Plug
Code 61/62 Block Flange or Pad Plug

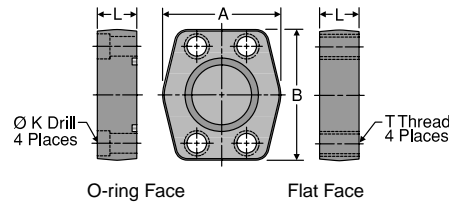

TUBE FITTING PART #		FLANGE SIZE (in.)	A (in.)	B (in.)	K DRILL DIA. (in.)	L (in.)	T THREAD UNC-2B	MOUNTING HARDWARE SHCS	Dynamic Pressure (x 1,000 PSI)	
O-RING FACE	FLAT FACE								SX	SS ¹
CODE 61 BLOCK FLANGE OR PAD PLUG										
8PQ1B	8PQ1P	0.50	1.813	2.125	0.344	0.750	5/16-18	5/16-18 x 1.50	5.0	
12PQ1B	12PQ1P	0.75	2.063	2.563	0.406	0.750	3/8-16	3/8-16 x 1.50	5.0	
16PQ1B	16PQ1P	1.00	2.313	2.750	0.406	0.880	3/8-16	3/8-16 x 1.75	5.0	
20PQ1B	20PQ1P	1.25	2.875	3.125	0.469	0.940	7/16-14	7/16-14 x 1.75	4.0	
24PQ1B	24PQ1P	1.50	3.250	3.688	0.531	1.190	1/2-13	1/2-13 x 2.25	3.0	
32PQ1B	32PQ1P	2.00	3.813	4.000	0.531	1.440	1/2-13	1/2-13 x 2.50	3.0	
40PQ1B	40PQ1P	2.50	4.281	4.500	0.531	1.815	1/2-13	1/2-13 x 2.75	2.5	
48PQ1B	48PQ1P	3.00	5.156	5.313	0.656	2.190	5/8-11	5/8-11 x 3.50	2.0	
56PQ1B	56PQ1P	3.50	5.500	6.000	0.656	1.440	5/8-11	5/8-11 x 2.75	0.5	
64PQ1B	64PQ1P	4.00	6.000	6.380	0.656	1.440	5/8-11	5/8-11 x 2.75	0.5	
CODE 62 BLOCK FLANGE OR PAD PLUG										
8PQ2B	8PQ2P	0.50	1.940	2.300	0.344	1.250	5/16-18	5/16-18 x 2.00	6.0	
12PQ2B	12PQ2P	0.75	2.500	2.950	0.406	1.250	3/8-16	3/8-16 x 2.00	6.0	
16PQ2B	16PQ2P	1.00	2.750	3.190	0.469	1.500	7/16-14	7/16-14 x 2.50	6.0	
20PQ2B	20PQ2P	1.25	3.060	3.750	0.531	1.430	1/2-13	1/2-13 x 2.50	6.0	
24PQ2B	24PQ2P	1.50	3.750	4.440	0.656	1.815	5/8-11	5/8-11 x 3.00	6.0	
32PQ2B	32PQ2P	2.00	4.500	5.250	0.781	1.815	3/4-10	3/4-10 x 3.00	6.0	
40PQ2B ²	40PQ2P ²	2.50	5.870	6.870	0.940	1.930	7/8-9	7/8-9 x 3.50	6.0	
48PQ2B ²	48PQ2P ²	3.00	7.000	8.500	1.190	2.690	1 1/8-7	1 1/8-7 x 4.50	6.0	

1) See page L40 for standard stainless steel sizes and dimensions.

2) SAE J518 does not cover these sizes in Code 62. Bolt hole centerline dimensions are: 2.312" x 4.875" for 40PQ2 and 2.812" x 6.000" for 48PQ2.

To receive mounting hardware with flange, insert a "K" after the material designator. Mounting hardware kits are available for O-ring Face part numbers and include 4 bolts, 4 lock washers and an O-ring.

Dimensions and pressures for reference only, subject to change.



SPGG5

Flange Spacer with Gage Ports
Code 61/62 Spacer with Side Gage Ports

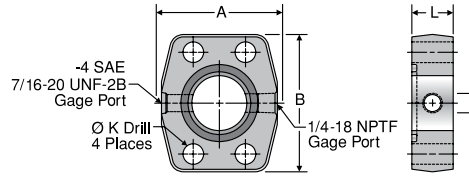

TUBE FITTING PART #	FLANGE SIZE (in.)	A (in.)	B (in.)	D (in.)	K DRILL DIA. (in.)	L (in.)	Dynamic Pressure (x 1,000 PSI)	
							SX	SS
CODE 61 O-RING SPACER								
8SPGG5Q1B	0.50	1.813	2.125	0.500	0.344	1.25	5.0	
12SPGG5Q1B	0.75	2.063	2.563	0.750	0.406	1.25	5.0	
16SPGG5Q1B	1.00	2.313	2.750	1.000	0.406	0.88	5.0	
20SPGG5Q1B	1.25	2.875	3.125	1.250	0.469	0.94	4.0	
24SPGG5Q1B	1.50	3.250	3.688	1.500	0.531	1.19	3.0	
32SPGG5Q1B	2.00	3.813	4.000	2.000	0.531	1.38	3.0	
40SPGG5Q1B	2.50	4.281	4.500	2.500	0.531	1.75	2.5	
48SPGG5Q1B	3.00	5.156	5.313	3.000	0.656	2.12	2.0	
CODE 62 O-RING SPACER								
8SPGG5Q2B	0.50	1.940	2.300	0.500	0.344	1.25	6.0	
12SPGG5Q2B	0.75	2.500	2.950	0.750	0.406	1.25	6.0	
16SPGG5Q2B	1.00	2.750	3.190	1.000	0.469	1.50	6.0	
20SPGG5Q2B	1.25	3.060	3.750	1.250	0.531	1.50	6.0	
24SPGG5Q2B	1.50	3.750	4.440	1.500	0.656	1.75	6.0	
32SPGG5Q2B	2.00	4.500	5.250	2.000	0.781	1.75	6.0	

CP

Flange Connector Plate
Code 61/62 Flange Connector Plate

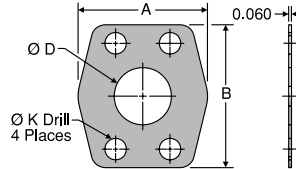

TUBE FITTING PART #	FLANGE SIZE (in.)	A (in.)	B (in.)	D (in.)	K DRILL DIA. (in.)	Dynamic Pressure (x 1,000 PSI)	
						SX	SS
CODE 61 FLANGE CONNECTOR PLATE							
8CP1	0.50	1.81	2.12	0.50	0.344	5.0	
12CP1	0.75	2.06	2.56	0.75	0.406	5.0	
16CP1	1.00	2.31	2.75	1.00	0.406	5.0	
20CP1	1.25	2.88	3.12	1.25	0.469	4.0	
24CP1	1.50	3.25	3.69	1.50	0.531	3.0	
32CP1	2.00	3.81	4.00	2.00	0.531	3.0	
40CP1	2.50	4.12	4.44	2.50	0.531	2.5	
48CP1	3.00	5.16	5.31	3.00	0.656	2.5	
CODE 62 FLANGE CONNECTOR PLATE							
12CP2	0.75	2.38	2.81	0.75	0.406	6.0	
16CP2	1.00	2.75	3.19	1.00	0.469	6.0	
20CP2	1.25	3.06	3.75	1.25	0.531	6.0	
24CP2	1.50	3.75	4.44	1.50	0.656	6.0	
32CP2	2.00	4.50	5.25	2.00	0.781	6.0	

Dimensions and pressures for reference only, subject to change.

LOVQ1

Code 61 Flange 45° Elbow
Code 61 / ORFS

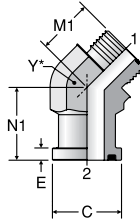

*Y – Across Wrench Flats

TUBE FITTING PART #	END SIZE		C (in.)	E (in.)	M1 (in.)	N1 (in.)	Y (in.)	Dynamic Pressure (x 1,000 PSI) -S
	1 (in.)	2 (in.)						
12 LOVQ1	3/4	3/4	1.500	0.265	1.20	1.58	1 7/16	5.0
16 LOVQ1	1	1	1.750	0.315	1.26	1.85	1 5/8	5.0
20 LOVQ1	1 1/4	1 1/4	2.000	0.315	1.29	2.40	1 7/8	4.0
24 LOVQ1	1 1/2	1 1/2	2.375	0.315	1.45	2.90	2 1/2	3.0

LOVQ2

Code 62 Flange 45° Elbow
Code 62 / ORFS

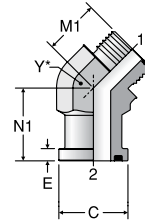

*Y – Across Wrench Flats

TUBE FITTING PART #	END SIZE		C (in.)	E (in.)	M1 (in.)	N1 (in.)	Y (in.)	Dynamic Pressure (x 1,000 PSI) -S
	1 (in.)	2 (in.)						
12 LOVQ2	3/4	3/4	1.625	0.345	1.20	1.83	1 7/16	6.0
16 LOVQ2	1	1	1.875	0.375	1.25	2.07	1 5/8	6.0
20 LOVQ2	1 1/4	1 1/4	2.125	0.405	1.29	2.40	1 7/8	5.0
24 LOVQ2	1 1/2	1 1/2	2.500	0.495	1.45	2.90	2 1/2	4.5

XVQ1

Code 61 Flange 45° Elbow
Code 61 / 37° Flare

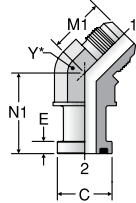

*Y – Across Wrench Flats

TUBE FITTING PART #	END SIZE		C (in.)	E (in.)	M1 (in.)	N1 (in.)	Y (in.)	Dynamic Pressure (x 1,000 PSI) -S
	1 (in.)	2 (in.)						
12 XVQ1	3/4	3/4	1.500	0.265	1.27	1.58	1 7/16	5.0
16 XVQ1	1	1	1.750	0.315	1.47	1.85	1 5/8	5.0
20 XVQ1	1 1/4	1 1/4	2.000	0.315	1.59	2.40	1 7/8	4.0
24 XVQ1	1 1/2	1 1/2	2.375	0.315	1.78	2.90	2 1/2	3.0
32 XVQ1	2	2	2.812	0.375	2.22	3.00	2 1/2	2.0

XVQ2

Code 62 Flange 45° Elbow
Code 62 / 37° Flare

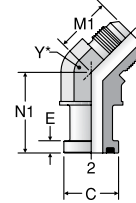

*Y – Across Wrench Flats

TUBE FITTING PART #	END SIZE		C (in.)	E (in.)	M1 (in.)	N1 (in.)	Y (in.)	Dynamic Pressure (x 1,000 PSI) -S
	1 (in.)	2 (in.)						
12 XVQ2	3/4	3/4	1.625	0.345	1.27	1.83	1 7/16	5.0
16 XVQ2	1	1	1.875	0.375	1.47	2.07	1 5/8	5.0
20 XVQ2	1 1/4	1 1/4	2.125	0.405	1.59	2.40	1 7/8	4.0
24 XVQ2	1 1/2	1 1/2	2.500	0.495	1.78	2.90	2 1/2	3.0

BUVQ1

Code 61 45° Elbow
Code 61 / Flareless

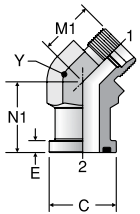

*Y – Across Wrench Flats

TUBE FITTING PART #	END SIZE		C (in.)	E (in.)	M1 (in.)	N1 (in.)	Y (in.)	Dynamic Pressure (x 1,000 PSI) -S
	1 (in.)	2 (in.)						
12 BUVQ1	3/4	3/4	1.500	0.265	1.27	1.58	1 7/16	
16 BUVQ1	1	1	1.750	0.315	1.36	1.85	1 5/8	
20 BUVQ1	1 1/4	1 1/4	2.000	0.315	1.45	2.40	1 7/8	
24 BUVQ1	1 1/2	1 1/2	2.375	0.315	1.52	2.90	2 1/2	
32 BUVQ1	2	2	2.812	0.375	1.83	3.00	2 1/2	

Dimensions and pressures for reference only, subject to change.

LOEQ1

Code 61 Flange 90° Elbow
Code 61 / ORFS

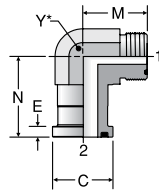

* Y – Across Wrench Flats

TUBE FITTING PART #	END SIZE		C (in.)	E (in.)	M (in.)	N (in.)	Y (in.)	Dynamic Pressure (x 1,000 PSI)		
	1 (in.)	2 (in.)						-S	-SS	-B
12 LOEQ1	3/4	3/4	1.500	0.265	1.95	1.81	1 3/16	5.0		
16 LOEQ1	1	1	1.750	0.315	2.05	2.13	1 7/16	5.0		
20 LOEQ1	1 1/4	1 1/4	2.000	0.315	2.22	2.26	1 5/8	4.0		
24 LOEQ1	1 1/2	1 1/2	2.375	0.315	2.54	2.64	2	3.0		

LOEQ2

Code 62 Flange 90° Elbow
Code 62 / ORFS

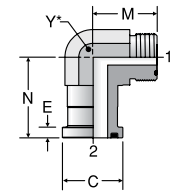

* Y – Across Wrench Flats

TUBE FITTING PART #	END SIZE		C (in.)	E (in.)	M (in.)	N (in.)	Y (in.)	Dynamic Pressure (x 1,000 PSI)		
	1 (in.)	2 (in.)						-S	-SS	-B
12 LOEQ2	3/4	3/4	1.625	0.345	2.01	2.01	1 3/16	6.0		
16 LOEQ2	1	1	1.875	0.375	2.17	2.42	1 7/16	6.0		
20 LOEQ2	1 1/4	1 1/4	2.125	0.405	2.50	2.68	1 5/8	5.0		
24 LOEQ2	1 1/2	1 1/2	2.500	0.495	2.87	3.13	2	4.5		

XEQ1

Code 61 Flange 90° Elbow
Code 61 / 37° Flare

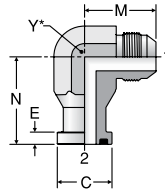

* Y – Across Wrench Flats

TUBE FITTING PART #	END SIZE		C (in.)	E (in.)	M (in.)	N (in.)	Y (in.)	Dynamic Pressure (x 1,000 PSI)		
	1 (in.)	2 (in.)						-S	-SS	-B
12 XEQ1	3/4	3/4	1.500	0.265	1.91	1.81	1 3/16	5.0		
16 XEQ1	1	1	1.750	0.315	2.07	2.13	1 7/16	5.0		
20 XEQ1	1 1/4	1 1/4	2.000	0.315	2.26	2.26	1 5/8	4.0		
24 XEQ1	1 1/2	1 1/2	2.375	0.315	2.72	2.64	2	3.0		
32 XEQ1	2	2	2.812	0.375	3.06	4.25	2 1/2	2.0		

XEQ2

Code 62 Flange 90° Elbow
Code 62 / 37° Flare

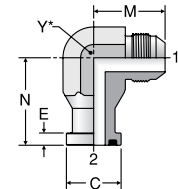

* Y – Across Wrench Flats

TUBE FITTING PART #	END SIZE		C (in.)	E (in.)	M (in.)	N (in.)	Y (in.)	Dynamic Pressure (x 1,000 PSI)		
	1 (in.)	2 (in.)						-S	-SS	-B
12 XEQ2	3/4	3/4	1.625	0.345	1.97	2.04	1 3/16	5.0		
16 XEQ2	1	1	1.875	0.375	2.19	2.42	1 7/16	5.0		
20 XEQ2	1 1/4	1 1/4	2.125	0.405	2.56	2.68	1 5/8	4.0		
24 XEQ2	1 1/2	1 1/2	2.500	0.495	3.03	3.13	2	3.0		

BUEQ1

Code 61 90° Elbow
Code 61 / Flareless

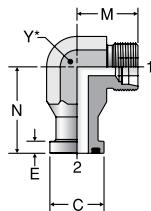

* Y – Across Wrench Flats

TUBE FITTING PART #	END SIZE		C (in.)	E (in.)	M (in.)	N (in.)	Y (in.)	Dynamic Pressure (x 1,000 PSI)		
	1 (in.)	2 (in.)						-S	-SS	-B
12 BUEQ1	3/4	3/4	1.500	0.265	1.73	1.81	1 3/16			
16 BUEQ1	1	1	1.750	0.315	1.99	2.13	1 7/16			
20 BUEQ1	1 1/4	1 1/4	2.000	0.315	1.99	2.26	1 5/8			
24 BUEQ1	1 1/2	1 1/2	2.375	0.315	2.33	2.64	2			
32 BUEQ1	2	2	2.812	0.375	2.45	4.25	2 1/2			

Dimensions and pressures for reference only, subject to change.

W7EQ

Weld Socket Block Elbow Connector, Pipe
Weld Socket, Pipe / Code 61 or 62
Block Flange or Pad

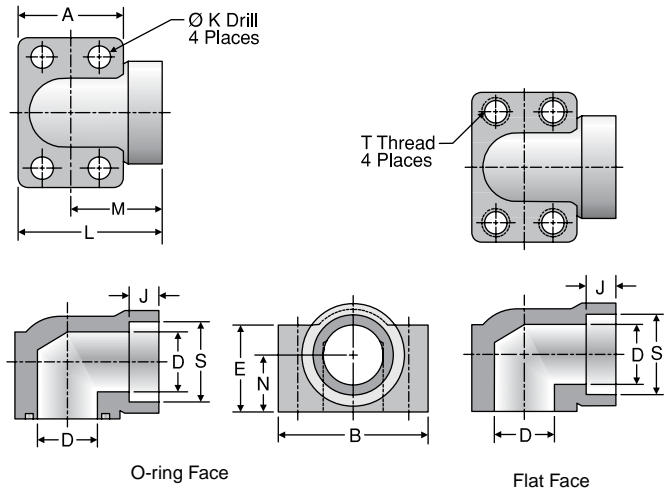

TUBE FITTING PART #		PIPE SIZE (in.)	FLANGE SIZE (in.)	A (in.)	B (in.)	D (in.)	E (in.)	J (in.)	K DRILL DIA. (in.)	L (in.)	M (in.)	N (in.)	S (in.)	T THREAD UNC-2B	MOUNTING HARDWARE SHCS	Dynamic Pressure (x 1,000 PSI)	
O-RING FACE	FLAT FACE															SX	SS
WELD SOCKET, PIPE / CODE 61 BLOCK FLANGE OR PAD																	
12W7EQ1B	12W7EQ1P	3/4	0.75	1.69	2.56	0.75	1.25	0.56	0.406	2.28	1.44	0.875	1.062	3/8-16	3/8-16 x 2.00	5.0	
16W7EQ1B	16W7EQ1P	1	1.00	1.94	2.75	1.00	1.50	0.56	0.406	2.62	1.66	1.062	1.328	3/8-16	3/8-16 x 2.25	4.5	
20W7EQ1B	20W7EQ1P	1 1/4	1.25	2.19	3.12	1.25	1.81	0.62	0.469	3.00	1.91	1.188	1.672	7/16-14	7/16-14 x 2.75	3.5	
24W7EQ1B	24W7EQ1P	1 1/2	1.50	2.56	3.69	1.50	2.00	0.69	0.531	3.33	2.05	1.312	1.922	1/2-13	1/2-13 x 3.00	3.0	
32W7EQ1B	32W7EQ1P	2	2.00	3.06	4.33	2.00	2.50	0.75	0.531	3.81	2.28	1.656	2.406	1/2-13	1/2-13 x 3.50	3.0	
WELD SOCKET, PIPE / CODE 62 BLOCK FLANGE OR PAD																	
12W7EQ2B	12W7EQ2P	3/4	0.75	1.94	2.75	0.75	1.50	0.56	0.406	2.62	1.66	1.062	1.062	3/8-16	3/8-16 x 2.25	6.0	
16W7EQ2B	16W7EQ2P	1	1.00	2.19	3.12	1.00	1.81	0.62	0.469	3.00	1.91	1.188	1.328	7/16-14	7/16-14 x 2.50	6.0	
20W7EQ2B	20W7EQ2P	1 1/4	1.25	2.56	3.69	1.25	2.00	0.69	0.531	3.32	2.05	1.312	1.672	1/2-13	1/2-13 x 3.00	5.0	
24W7EQ2B	24W7EQ2P	1 1/2	1.50	3.06	4.33	1.50	2.50	0.75	0.656	3.81	2.28	1.656	1.922	5/8-11	5/8-11 x 3.50	5.0	

To receive mounting hardware with flange, insert a "K" after the material designator. Mounting hardware kits are available for O-ring Face part numbers and include 4 bolts, 4 lock washers and an O-ring.

Dimensions and pressures for reference only, subject to change.

WFS

SAE Flange Connection
Code 61 & 62 / Metric Flareless

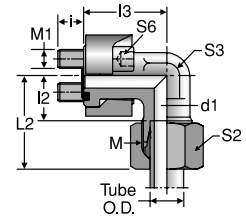

TUBE FITTING PART #	SIZE (in.)	END SIZE (mm)	WORKING PRESSURE (bar)	M THREAD	d1 (mm)	l (mm)	l1 (mm)	l2 (mm)	l3 (mm)	L1 ≈ (mm)	L2 ≈ (mm)	S1 (mm)	S2 (mm)	S3 (mm)	S6 (mm)	FROM STOCK		FROM STOCK	
																CF	71	CF	71
SAE FLANGE CONNECTIONS – CODE 61 – STANDARD SERIES																			
WFS32/15LCF	1/2	15L	200	M22 x 1.5	12	11.5	41	29	36	56	44	24	27	24	6	•		•	
WFS32/16SCF	1/2	16S	220	M24 x 1.5	12	11.5	41.5	29.5	36	60	48	24	30	24	6	•		•	
WFS33/18LCF	3/4	18L	200	M26 x 1.5	15	15.5	45.5	31.5	42	62	48	30	32	30	8	•		•	
WFS33/22LCF	3/4	22L	100	M30 x 2	19	15.5	45.5	33.5	42	62	50	30	36	30	8	•		•	
WFS33/20SCF	3/4	20S	220	M30 x 2	16	15.5	46.5	32.5	42	68	54	30	36	30	8	•		•	
WFS33/25SCF	3/4	25S	220	M36 x 2	17	15.5	45	33	42	69	57	30	46	30	8	•		•	
WFS34/28LCF	1	28L	100	M36 x 2	24	13.5	46.5	36.5	45	63	53	36	41	36	8	•		•	
WFS34/30SCF	1	30S	220	M42 x 2	24	13.5	49.5	36.5	45	76	63	36	50	36	8	•		•	
WFS35/35LCF	1 1/4	35L	100	M45 x 2	30	18.5	47.5	46.5	50	69	68	41	50	41	8	•		•	
WFS35/25SCF	1 1/4	25S	175	M36 x 2	20	18.5	48	43	50	72	67	41	46	41	8	•		•	
WFS35/30SCF	1 1/4	30S	175	M42 x 2	25	18.5	48.5	43.5	50	75	70	41	50	41	8	•		•	
WFS35/38SCF	1 1/4	38S	175	M52 x 2	28	18.5	50	43	50	81	74	46	60	41	8	•		•	
WFS36/42LCF	1 1/2	42L	100	M52 x 2	36	18.5	53	47	55	76	70	46	60	50	10	•		•	
WFS36/38SCF	1 1/2	38S	130	M52 x 2	32	18.5	54	48	55	85	79	46	60	50	10	•		•	
SAE FLANGE CONNECTIONS – CODE 62 – HIGH PRESSURE SERIES																			
WFS62/16SCF	1/2	16S	250	M24 x 1.5	12	13.5	44.5	29.5	39	63	48	24	30	24	6	•		•	
WFS63/16SCF	3/4	16S	250	M24 x 1.5	12	15.5	50.5	36.5	48	69	55	30	30	32	8	•		•	
WFS63/20SCF	3/4	20S	250	M30 x 2	16	15.5	50.5	35.5	48	72	57	30	36	32	8	•		•	
WFS63/25SCF	3/4	25S	250	M36 x 2	17	15.5	51	36	48	75	60	30	46	32	8	•		•	
WFS64/25SCF	1	25S	250	M36 x 2	20	20.5	60	44	60	84	65	36	46	41	10	•		•	
WFS64/30SCF	1	30S	250	M42 x 2	24	20.5	60.5	41.5	60	87	68	36	50	41	10	•		•	
WFS65/30SCF	1 1/4	30S	250	M42 x 2	25	22.5	65.5	44.5	68	92	71	41	50	46	10	•		•	
WFS65/38SCF	1 1/4	38S	200	M52 x 2	30	22.5	67	45	68	98	76	46	60	46	10	•		•	
WFS66/38SCF	1 1/2	38S	200	M52 x 2	30	24.5	73	56	76	104	87	46	60	50	14	•		•	

EO-2 Part Number example: WFS33/18ZLCF

Temperature range without pressure reductions for fittings with O-ring sealing of NBR (e.g., buna N series) -35°C up to +100°C, FPM (e.g., fluorocarbon on request) -25°C up to +120°C.

Tightening torques for socket head cap screws see Tables S6 and S7.

Dimensions and pressures for reference only, subject to change.



BFW

Hydraulic Flange Elbow
DIN Flange / Metric Flareless

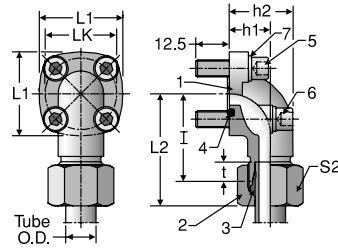

TUBE FITTING PART #	WORKING PRESSURE (bar)	END SIZE (mm)	h1 (mm)	h1 (mm)	l (mm)	L1 (mm)	L2 (mm)	LK (mm)	S2 (mm)	t (mm)	MATERIAL FROM STOCK		EO-2 FROM STOCK	
											CF	71	CF	71
BFW15L/LK40CF	65	15	22.5	36.5	38	42	46	40	27	7	•		•	
BFW18L/LK40CF	65	18	22.5	36.5	38	42	47	40	32	7.5	•		•	
BFW22L/LK40CF	65	22	22.5	36.5	38	42	47.5	40	36	7.5	•		•	
BFW28L/LK40CF	65	28	28	43	40	42	49	40	41	7.5	•		•	
BFW35L/LK40CF	65	35	32	55	41	42	52	40	50	10.5	•		•	
BFW35L/LK55CF	65	35	32	51.5	49	58	62	55	50	10.5	•		•	
BFW42L/LK55CF	65	42	40	64.5	49	58	61	55	60	11	•		•	
BFW15L/LK35CF	155	15	16.5	26.5	38	39	46	35	27	7	•		•	
BFW20S/LK55CF	155	20	24	38	45	58	56	55	36	10.5	•		•	
BFW20S/LK40CF	155	20	22.5	35.5	40	42	50	40	36	10.5	•		•	
BFW25S/LK55CF	155	25	30	46	49	58	61	55	46	12	•		•	
BFW30S/LK55CF	155	30	32	50	49	58	62	55	50	13.5	•		•	
BFW10L/LK35CF	200	10	16.5	26.5	38	39	47	35	19	7	•		•	
BFW12L/LK35CF	200	12	16.5	26.5	38	39	47	35	22	7	•		•	
BFW16S/LK35CF	200	16	20	31	38	39	48	35	30	8.5	•		•	

Unassembled BFW Fitting Components

1 Elbow Body	2 Nut	3 Progressive Ring	4 O-Ring	5 2 Cap Screws DIN 912-8.8	6 2 Cap Screws DIN 912-8.8	7 4 Spr. Washers DIN 127
BFW15L/LK40CFX	M15LCFX	DPR15LCFX	OR26X2.5X	M6X22	M6X22	A6
BFW18L/LK40CFX	M18LCFX	DPR18LCFX	OR26X2.5X	M6X22	M6X22	A6
BFW22L/LK40CFX	M22LCFX	DPR22LCFX	OR26X2.5X	M6X22	M6X22	A6
BFW28L/LK40CFX	M28LCFX	DPR28LCFX	OR26X2.5X	M6X20	M6X50	A6
BFW35L/LK40CFX	M35LCFX	DPR35LCFX	OR26X2.5X	M6X22	M6X60	A6
BFW35L/LK55CFX	M35LCFX	DPR35LCFX	OR33X2.5X	M8X25	M8X60	A8
BFW42L/LK55CFX	M42LCFX	DPR42LCFX	OR33X2.5X	M8X25	M8X70	A8
BFW15L/LK35CFX	M15LCFX	DPR15LCFX	OR20X2.5X	M6X22	M6X35	A6
BFW20S/LK55CFX	M20SCFX	DPR20SCFX	OR33X2.5X	M8X25	M8X50	A8
BFW20S/LK40CFX	M20SCFX	DPR20SCFX	OR26X2.5X	M6X22	M6X45	A6
BFW25S/LK55CFX	M25SCFX	DPR25SCFX	OR33X2.5X	M8X25	M8X55	A8
BFW30S/LK55CFX	M30SCFX	DPR20SCFX	OR33X2.5X	M8X25	M8X55	A8
BFW10L/LK35CFX	M10LCFX	DRP10LCFX	OR20X2.5X	M6X22	M6X35	A6
BFW12L/LK35CFX	M12LCFX	DPR12LCFX	OR20X2.5X	M6X22	M6X35	A6
BFW16S/LK35CFX	M16SCFX	DPR16SCFX	OR20X2.5X	M6X22	M6X40	A6
BFW20S/LK35CFX	M20SCFX	DPR20SCFX	OR20X2.5X	M6X22	M6X45	A6

EO-2 Part Number example: BFW15ZL/LK40CF

Temperature range without pressure reductions for fittings with O-ring sealing of NBR (e.g., buna N series) -35°C up to +100°C, FPM (e.g., fluorocarbon on request) -25°C up to +120°C.

Tightening torques for socket head cap screws see Table S6.

Dimensions and pressures for reference only, subject to change.



QPQPJQ

Block Junction Tee

Code 61 or 62 Block Pads / Block Flange or Pad

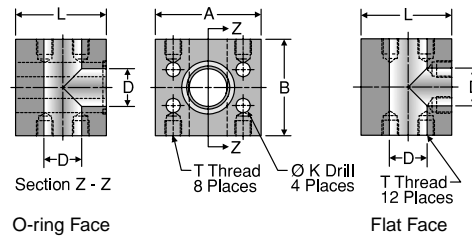

TUBE FITTING PART #		FLANGE SIZE (in.)	A (in.)	B (in.)	D (in.)	K DRILL DIA. (in.)	L (in.)	T THREAD UNC-2B	Dynamic Pressure (x 1,000 PSI)	
O-RING FACE	FLAT FACE								SX	SS
CODE 61 BLOCK PADS / BLOCK FLANGE OR PAD										
12Q1PQ1PJQ1B	12Q1PQ1PJQ1P	0.75	2.62	2.75	0.75	0.406	2.25	3/8-16	5.0	
16Q1PQ1PJQ1B	16Q1PQ1PJQ1P	1.00	2.82	3.00	1.00	0.406	2.50	3/8-16	5.0	
20Q1PQ1PJQ1B	20Q1PQ1PJQ1P	1.25	3.19	3.50	1.25	0.469	3.00	7/16-14	4.0	
24Q1PQ1PJQ1B	24Q1PQ1PJQ1P	1.50	3.75	4.00	1.50	0.531	3.50	1/2-13	3.0	
32Q1PQ1PJQ1B	32Q1PQ1PJQ1P	2.00	4.00	4.25	2.00	0.531	4.00	1/2-13	3.0	
CODE 62 BLOCK PADS / BLOCK FLANGE OR PAD										
12Q2PQ2PJQ2B	12Q2PQ2PJQ2P	0.75	2.81	3.00	0.75	0.406	2.50	3/8-16	6.0	
16Q2PQ2PJQ2B	16Q2PQ2PJQ2P	1.00	3.19	3.50	1.00	0.469	3.00	7/16-14	6.0	
20Q2PQ2PJQ2B	20Q2PQ2PJQ2P	1.25	3.75	4.00	1.25	0.531	3.50	1/2-13	6.0	
24Q2PQ2PJQ2B	24Q2PQ2PJQ2P	1.50	4.50	4.50	1.50	0.656	4.00	5/8-11	6.0	
32Q2PQ2PJQ2B	32Q2PQ2PJQ2P	2.00	5.25	5.00	1.94	0.781	5.00	3/4-10	6.0	

G5EQ

SAE Port Block Elbow

SAE Port / Code 61 or 62 Block Flange or Pad

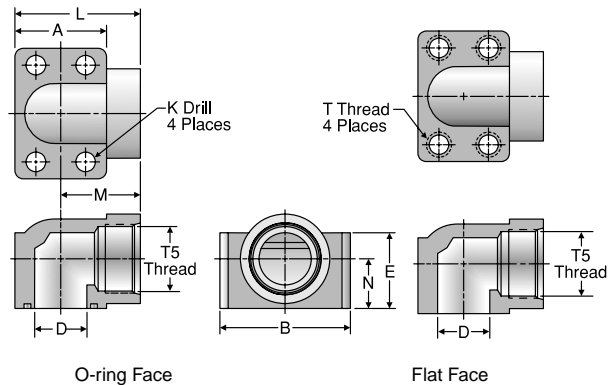

TUBE FITTING PART #		T5 STRAIGHT THREAD UN-2B	SAE PORT DASH SIZE	FLANGE SIZE (in.)	A (in.)	B (in.)	D (in.)	E (in.)	K DRILL DIA. (in.)	L (in.)	M (in.)	N (in.)	T THREAD UNC-2B	MOUNTING HARDWARE SHCS		Dynamic Pressure (x 1,000 PSI)	
O-RING FACE	FLAT FACE													SX	SS		
SAE PORT / CODE 61 BLOCK FLANGE OR PAD																	
12G5EQ1B	12G5EQ1P	1-1/16-12	12	0.75	1.69	2.56	0.75	1.25	0.406	2.28	1.440	0.875	3/8-16	3/8-16 x 2.00	4.0		
16G5EQ1B	16G5EQ1P	1-5/16-12	16	1.00	1.94	2.75	1.00	1.50	0.406	2.62	1.660	1.062	3/8-16	3/8-16 x 2.25	3.0		
20G5EQ1B	20G5EQ1P	1-5/8-12	20	1.25	2.19	3.12	1.25	1.81	0.469	3.00	1.910	1.188	7/16-14	7/16-14 x 2.75	2.5		
24G5EQ1B	24G5EQ1P	1-7/8-12	24	1.50	2.56	3.69	1.50	2.00	0.531	3.33	2.050	1.312	1/2-13	1/2-13 x 3.00	2.0		
32G5EQ1B	32G5EQ1P	2-1/2-12	32	2.00	3.06	4.33	2.00	2.50	0.531	3.81	2.280	1.656	1/2-13	1/2-13 x 3.50	1.5		
SAE PORT / CODE 62 BLOCK FLANGE OR PAD																	
12G5EQ2B	12G5EQ2P	1-1/16-12	12	0.75	1.94	2.75	0.75	1.50	0.406	2.62	1.660	1.062	3/8-16	3/8-16 x 2.25	5.0		
16G5EQ2B	16G5EQ2P	1-5/16-12	16	1.00	2.19	3.12	1.00	1.81	0.469	3.00	1.910	1.188	7/16-14	7/16-14 x 2.50	4.0		
20G5EQ2B	20G5EQ2P	1-5/8-12	20	1.25	2.56	3.69	1.25	2.00	0.531	3.32	2.050	1.312	1/2-13	1/2-13 x 3.00	3.5		
24G5EQ2B	24G5EQ2P	1-7/8-12	24	1.50	3.06	4.33	1.50	2.50	0.656	3.81	2.280	1.656	5/8-11	5/8-11 x 3.50	3.5		

To receive mounting hardware with flange, insert a "K" after the material designator. Mounting hardware kits are available for O-ring Face part numbers and include 4 bolts, 4 lock washers and an O-ring.

Dimensions and pressures for reference only, subject to change.



GEQ

NPTF Port Block Elbow Adapter
NPTF / Code 61 or 62 Block Flange or Pad

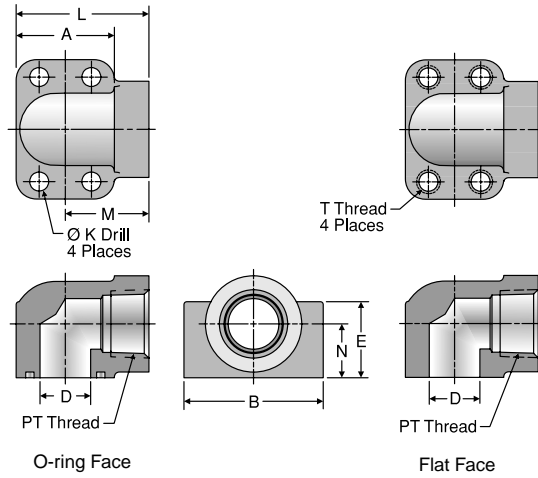

TUBE FITTING PART #		PT THREAD NPTF	FLANGE SIZE (in.)	A (in.)	B (in.)	D (in.)	E (in.)	K DRILL DIA. (in.)	L (in.)	M (in.)	N (in.)	T THREAD UNC-2B	MOUNTING HARDWARE SHCS	Dynamic Pressure (x 1,000 PSI)	
O-RING FACE	FLAT FACE													SX	SS
NPTF PORT / CODE 61 BLOCK FLANGE OR PAD															
12GEQ1B	12GEQ1P	3/4 - 14	0.75	1.69	2.56	0.75	1.25	0.406	2.28	1.440	0.875	3/8-16	3/8-16 x 2.00	4.0	
16GEQ1B	16GEQ1P	1 - 11 1/2	1.00	1.94	2.75	1.00	1.50	0.406	2.62	1.660	1.062	3/8-16	3/8-16 x 2.25	4.0	
20GEQ1B	20GEQ1P	1 1/4 - 11 1/2	1.25	2.19	3.12	1.25	1.81	0.469	3.00	1.910	1.188	7/16-14	7/16-14 x 2.75	2.7	
24GEQ1B	24GEQ1P	1 1/2 - 11 1/2	1.50	2.56	3.69	1.50	2.00	0.531	3.33	2.050	1.312	1/2-13	1/2-13 x 3.00	2.5	
32GEQ1B	32GEQ1P	2 - 11 1/2	2.00	3.06	4.33	2.00	2.50	0.531	3.81	2.280	1.656	1/2-13	1/2-13 x 3.50	1.7	
NPTF PORT / CODE 62 BLOCK FLANGE OR PAD															
12GEQ2B	12GEQ2P	3/4 - 14	0.75	1.94	2.75	0.75	1.50	0.406	2.62	1.660	1.062	3/8-16	3/8-16 x 2.25	5.5	
16GEQ2B	16GEQ2P	1 - 11 1/2	1.00	2.19	3.12	1.00	1.81	0.469	3.00	1.910	1.188	7/16-14	7/16-14 x 2.50	5.0	
20GEQ2B	20GEQ2P	1 1/4 - 11 1/2	1.25	2.56	3.69	1.25	2.00	0.531	3.32	2.050	1.312	1/2-13	1/2-13 x 3.00	3.5	
24GEQ2B	24GEQ2P	1 1/2 - 11 1/2	1.50	3.06	4.33	1.50	2.50	0.656	3.81	2.280	1.656	5/8-11	5/8-11 x 3.50	3.0	

To receive mounting hardware with flange, insert a "K" after the material designator. Mounting hardware kits are available for O-ring Face part numbers and include 4 bolts, 4 lock washers and an O-ring.

Dimensions and pressures for reference only, subject to change.

W6EQ

Weld Socket Block Elbow Connector, Tube
Weld Socket, Tube / Code 61 or 62 Block Flange or Pad

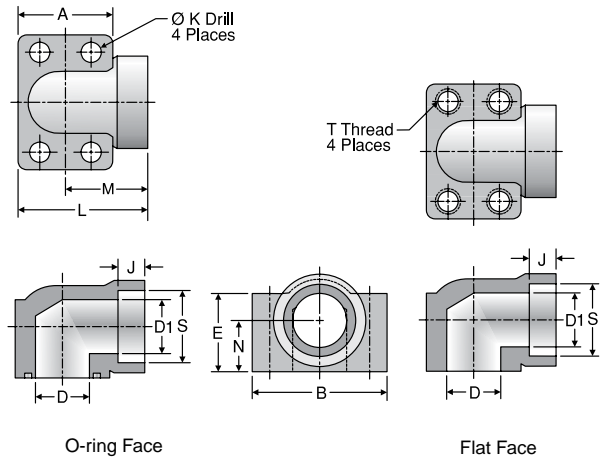

TUBE FITTING PART #		TUBE O.D. (in.)	FLANGE SIZE (in.)	A (in.)	B (in.)	D (in.)	D1 (in.)	E (in.)	J (in.)	K DRILL DIA. (in.)	L (in.)	M (in.)	N (in.)	S (in.)	T THREAD UNC-2B	MOUNTING HARDWARE SHCS		Dynamic Pressure (x 1,000 PSI)		
O-RING FACE	FLAT FACE															SX	SS	SX	SS	
WELD SOCKET, TUBE / CODE 61 BLOCK FLANGE OR PAD																				
12W6EQ1B	12W6EQ1P	3/4	0.75	1.69	2.56	0.75	0.63	1.25	0.312	0.406	2.280	1.44	0.875	0.752	3/8-16	3/8-16 x 2.00	5.0			
16-12W6EQ1B	16-12W6EQ1P	1	0.75	1.69	2.56	0.75	0.75	1.25	0.438	0.406	2.280	1.44	0.875	1.002	3/8-16	3/8-16 x 2.00	5.0			
16W6EQ1B	16W6EQ1P	1	1.00	1.94	2.75	1.00	0.88	1.50	0.438	0.406	2.620	1.66	1.062	1.002	3/8-16	3/8-16 x 2.25	5.0			
20-16W6EQ1B	20-16W6EQ1P	1 1/4	1.00	1.94	2.75	1.00	1.00	1.50	0.500	0.406	2.620	1.66	1.062	1.252	3/8-16	3/8-16 x 2.25	5.0			
20W6EQ1B	20W6EQ1P	1 1/4	1.25	2.19	3.12	1.25	1.13	1.81	0.500	0.469	3.000	1.91	1.188	1.252	7/16-14	7/16-14 x 2.75	4.0			
24-20W6EQ1B	24-20W6EQ1P	1 1/2	1.25	2.19	3.12	1.25	1.25	1.81	0.562	0.469	3.000	1.91	1.188	1.502	7/16-14	7/16-14 x 2.75	4.0			
24W6EQ1B	24W6EQ1P	1 1/2	1.50	2.56	3.69	1.50	1.38	2.00	0.562	0.531	3.328	2.05	1.312	1.502	1/2-13	1/2-13 x 3.00	3.0			
28-24W6EQ1B	28-24W6EQ1P	1 3/4	1.50	2.56	3.69	1.50	1.50	2.00	0.562	0.531	3.328	2.05	1.312	1.752	1/2-13	1/2-13 x 3.00	3.0			
32W6EQ1B	32W6EQ1P	2	2.00	3.06	4.33	2.00	1.88	2.50	0.625	0.531	3.812	2.28	1.656	2.002	1/2-13	1/2-13 x 3.50	3.0			
36-32W6EQ1B	36-32W6EQ1P	2 1/4	2.00	3.06	4.33	2.00	2.00	2.50	0.625	0.531	3.812	2.28	1.656	2.252	1/2-13	1/2-13 x 3.50	3.0			
WELD SOCKET, TUBE / CODE 62 BLOCK FLANGE OR PAD																				
12W6EQ2B	12W6EQ2P	3/4	0.75	1.94	2.75	0.75	0.63	1.50	0.560	0.406	2.620	1.66	1.062	0.752	3/8-16	3/8-16 x 2.25	6.0			
16-12W6EQ2B	16-12W6EQ2P	1	0.75	1.94	2.75	0.75	0.75	1.50	0.620	0.406	2.620	1.66	1.062	1.002	3/8-16	3/8-16 x 2.25	6.0			
16W6EQ2B	16W6EQ2P	1	1.00	2.19	3.12	1.00	0.88	1.81	0.620	0.469	3.000	1.91	1.188	1.002	7/16-14	7/16-14 x 2.50	6.0			
20-16W6EQ2B	20-16W6EQ2P	1 1/4	1.00	2.19	3.12	1.00	1.00	1.81	0.690	0.469	3.000	1.91	1.188	1.252	7/16-14	7/16-14 x 2.50	6.0			
20W6EQ2B	20W6EQ2P	1 1/4	1.25	2.56	3.69	1.25	1.13	2.00	0.690	0.531	3.320	2.05	1.312	1.252	1/2-13	1/2-13 x 3.00	6.0			
24-20W6EQ2B	24-20W6EQ2P	1 1/2	1.25	2.56	3.69	1.25	1.25	2.00	0.750	0.531	3.320	2.05	1.312	1.502	1/2-13	1/2-13 x 3.00	6.0			
24W6EQ2B	24W6EQ2P	1 1/2	1.50	3.06	4.33	1.50	1.38	2.50	0.750	0.656	3.810	2.28	1.656	1.502	5/8-11	5/8-11 x 3.50	6.0			
28-24W6EQ2B	28-24W6EQ2P	1 3/4	1.50	3.06	4.33	1.50	1.50	2.50	0.750	0.656	3.810	2.28	1.656	1.752	5/8-11	5/8-11 x 3.50	6.0			

To receive mounting hardware with flange, insert a "K" after the material designator. Mounting hardware kits are available for O-ring Face part numbers and include 4 bolts, 4 lock washers and an O-ring.

Dimensions and pressures for reference only, subject to change.



G5Q – Stainless Steel

SAE Port Block Flange Adapter
SAE Port / Code 61 or 62 Block Flange

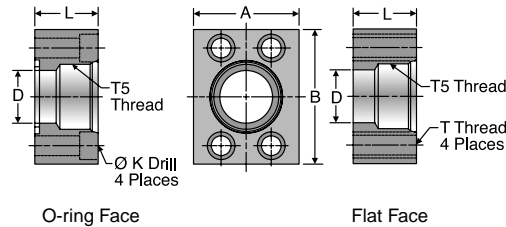

TUBE FITTING PART #		SAE PORT DASH SIZE	FLANGE SIZE (in.)	A (in.)	B (in.)	D (in.)	K DRILL DIA. (in.)	L (in.)	T5 STRAIGHT THREAD UN-2B	MOUNTING HARDWARE SHCS	Dynamic Pressure (x 1,000 PSI) SS
O-RING FACE	FLAT FACE										
SAE PORT / CODE 61 FLANGE BLOCK											
8G5Q1B	*	8	0.50	1.50	2.12	0.50	0.344	1.20	3/4-16	5/16-18 x 1.25	5.0
12G5Q1B	*	12	0.75	1.75	2.62	0.75	0.406	1.20	1 1/16-12	3/8-16 x 1.50	5.0
16G5Q1B	*	16	1.00	2.00	2.82	1.00	0.406	1.45	1 5/16-12	3/8-16 x 1.50	5.0
20G5Q1B	*	20	1.25	2.50	3.19	1.25	0.469	1.45	1 5/8-12	7/16-14 x 1.75	4.0
24G5Q1B	*	24	1.50	2.75	3.75	1.50	0.531	1.70	1 7/8-12	1/2-13 x 2.00	3.0
32G5Q1B	*	32	2.00	3.25	4.00	2.00	0.531	1.70	2 1/2-12	1/2-13 x 2.00	
SAE PORT / CODE 62 FLANGE BLOCK											
8G5Q2B	*	8	0.50	1.75	2.22	0.50	0.344	0.95	3/4-16	5/16-18 x 1.25	6.0
12G5Q2B	*	12	0.75	2.00	2.81	0.75	0.406	1.20	1 1/16-12	3/8-16 x 1.50	6.0
16G5Q2B	*	16	1.00	2.25	3.19	1.00	0.469	1.45	1 5/16-12	7/16-14 x 1.75	6.0
20G5Q2B	*	20	1.25	2.75	3.75	1.25	0.531	1.45	1 5/8-12	1/2-13 x 1.75	6.0
24G5Q2B	*	24	1.50	3.25	4.50	1.50	0.656	1.70	1 7/8-12	5/8-11 x 2.00	5.0
32G5Q2B	*	32	2.00	4.00	5.25	2.00	0.781	1.70	2 1/2-12	3/4-10 x 2.25	3.0

* Consult factory.

To receive mounting hardware with flange, insert a “K” after the material designator. Mounting hardware kits are available for O-ring Face part numbers and include 4 bolts, 4 lock washers and an O-ring.

GQ – Stainless Steel

NPTF Port Block Flange Adapter
NPTF Port / Code 61 or 62 Block Flange

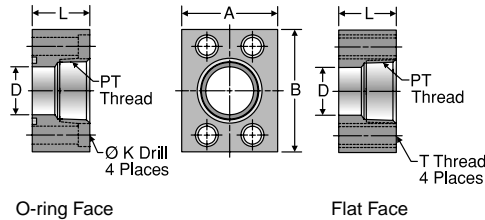

TUBE FITTING PART #		PT THREAD NPTF	FLANGE SIZE (in.)	A (in.)	B (in.)	D (in.)	K DRILL DIA. (in.)	L (in.)	MOUNTING HARDWARE SHCS	Dynamic Pressure (x 1,000 PSI) SS
O-RING FACE	FLAT FACE									
NPTF PORT / CODE 61 BLOCK FLANGE										
8GQ1B	*	1/2-14	0.50	1.50	2.12	0.50	0.344	1.25	5/16-18 x 1.75	5.0
12GQ1B	*	3/4-14	0.75	1.75	2.62	0.75	0.406	1.25	3/8-16 x 2.00	5.0
16GQ1B	*	1-11 1/2	1.00	2.00	2.82	1.00	0.406	1.50	3/8-16 x 2.25	5.0
20GQ1B	*	1 1/4-11 1/2	1.25	2.50	3.19	1.25	0.469	1.50	7/16-14 x 2.25	4.0
24GQ1B	*	1 1/2-11 1/2	1.50	2.75	3.75	1.50	0.531	1.75	1/2-13 x 2.50	3.0
32GQ1B	*	2-11 1/2	2.00	3.25	4.00	2.00	0.531	1.75	1/2-13 x 2.50	2.7
40GQ1B	*	2 1/2-8	2.50	4.00	4.50	2.50	0.531	2.00	1/2-13 x 2.75	2.5
48GQ1B	*	3-8	3.00	4.50	5.31	3.00	0.656	2.25	5/8-11 x 3.00	1.2
NPTF PORT / CODE 62 BLOCK FLANGE										
12GQ2B	*	3/4-14	0.75	2.00	2.81	0.75	0.406	1.20	3/8-16 x 2.00	6.0
16GQ2B	*	1-11 1/2	1.00	2.25	3.19	1.00	0.469	1.45	7/16-14 x 2.50	5.0
20GQ2B	*	1 1/4-11 1/2	1.25	2.75	3.75	1.25	0.531	1.45	1/2-13 x 2.50	4.0
24GQ2B	*	1 1/2-11 1/2	1.50	3.25	4.50	1.50	0.656	1.70	5/8-11 x 2.75	3.5
32GQ2B	*	2-11 1/2	2.00	4.00	5.25	2.00	0.781	1.70	3/4-10 x 3.00	3.0

* Consult factory.

To receive mounting hardware with flange, insert a “K” after the material designator. Mounting hardware kits are available for O-ring Face part numbers and include 4 bolts, 4 lock washers and an O-ring.

Dimensions and pressures for reference only, subject to change.



W5Q – Stainless Steel

Flat Weld Socket Block Flange Connector, Pipe
Flat Weld Socket, Pipe / Code 61 or 62
Block Flange or Pad

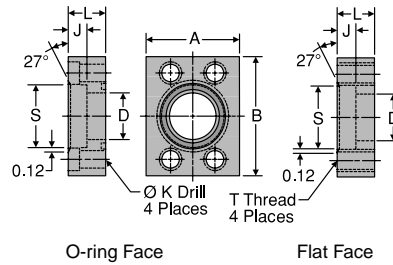

TUBE FITTING PART #		PIPE SIZE (in.)	FLANGE SIZE (in.)	A (in.)	B (in.)	D (in.)	J (in.)	K DRILL DIA. (in.)	L (in.)	S (in.)	T THREAD UNC-2B	MOUNTING HARDWARE SHCS	Dynamic Pressure (x 1,000 PSI) SS
O-RING FACE	FLAT FACE												
FLAT WELD SOCKET, PIPE / CODE 61 BLOCK FLANGE OR PAD													
8W5Q1B	8W5Q1P	1/2	0.50	1.50	2.12	0.500	0.380	0.344	0.69	0.860	5/16-18	5/16-18 x 1.25	5.0
12W5Q1B	12W5Q1P	3/4	0.75	1.75	2.62	0.750	0.500	0.406	0.94	1.070	3/8-16	3/8-16 x 1.75	5.0
16W5Q1B	16W5Q1P	1	1.00	2.00	2.82	1.000	0.500	0.406	0.94	1.335	3/8-16	3/8-16 x 1.75	5.0
20W5Q1B	20W5Q1P	1 1/4	1.25	2.50	3.19	1.250	0.500	0.469	0.94	1.680	7/16-14	7/16-14 x 1.75	4.0
24W5Q1B	24W5Q1P	1 1/2	1.50	2.75	3.75	1.500	0.500	0.531	1.19	1.920	1/2-13	1/2-13 x 2.25	3.0
32W5Q1B	32W5Q1P	2	2.00	3.25	4.00	2.000	0.620	0.531	1.44	2.411	1/2-13	1/2-13 x 2.50	3.0
40W5Q1B	40W5Q1P	2 1/2	2.50	4.00	4.50	2.500	0.750	0.531	1.69	2.911	1/2-13	1/2-13 x 2.75	2.5
48W5Q1B	48W5Q1P	3	3.00	4.50	5.31	3.000	1.240	0.656	2.12	3.540	5/8-11	5/8-11 x 3.50	2.0
FLAT WELD SOCKET, PIPE / CODE 62 BLOCK FLANGE OR PAD													
8W5Q2B	8W5Q2P	1/2	0.50	1.75	2.22	0.500	0.500	0.344	0.94	0.860	5/16-18	5/16-18 x 1.50	6.0
12W5Q2B	12W5Q2P	3/4	0.75	2.00	2.81	0.750	0.500	0.406	0.94	1.070	3/8-16	3/8-16 x 1.75	6.0
16W5Q2B	16W5Q2P	1	1.00	2.25	3.19	1.000	0.500	0.469	0.94	1.335	7/16-14	7/16-14 x 1.75	6.0
20W5Q2B	20W5Q2P	1 1/4	1.25	2.75	3.75	1.250	0.500	0.531	1.19	1.672	1/2-13	1/2-13 x 2.25	6.0
24W5Q2B	24W5Q2P	1 1/2	1.50	3.25	4.50	1.500	0.500	0.656	1.44	1.920	5/8-11	5/8-11 x 2.75	6.0
32W5Q2B	32W5Q2P	2	2.00	4.00	5.25	2.000	0.620	0.781	1.69	2.411	3/4-10	3/4-10 x 3.00	6.0
40W5Q2B	40W5Q2P	2 1/2	2.50	5.00	6.88	2.500	0.620	0.906	1.94	2.911	7/8-9	7/8-9 x 3.50	6.0
48W5Q2B	48W5Q2P	3	3.00	6.00	8.50	3.000	0.620	1.156	2.44	3.540	1 1/8-7	1 1/8-7 x 4.50	6.0

To receive mounting hardware with flange, insert a "K" after the material designator. Mounting hardware kits are available for O-ring Face part numbers and include 4 bolts, 4 lock washers and an O-ring.

Dimensions and pressures for reference only, subject to change.

PQ – Stainless Steel

Block Plug

Code 61/62 Block Flange or Pad Plug

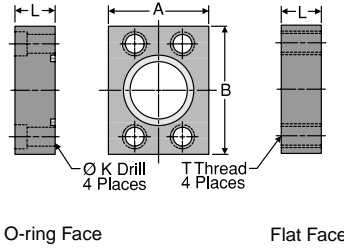

TUBE FITTING PART #		FLANGE SIZE (in.)	A (in.)	B (in.)	K DRILL DIA. (in.)	L (in.)	T THREAD UNC-2B	MOUNTING HARDWARE SHCS	Dynamic Pressure (x 1,000 PSI) SS
O-RING FACE	FLAT FACE								
CODE 61 BLOCK FLANGE OR PAD PLUG									
8PQ1B	8PQ1P	0.50	1.500	2.120	0.344	1.20	5/16-18	5/16-18 x 2.00	5.0
12PQ1B	12PQ1P	0.75	1.750	2.620	0.406	1.20	3/8-16	3/8-16 x 2.00	5.0
16PQ1B	16PQ1P	1.00	2.000	2.820	0.406	1.45	3/8-16	3/8-16 x 2.25	5.0
20PQ1B	20PQ1P	1.25	2.500	3.190	0.469	1.45	7/16-14	7/16-14 x 2.25	4.0
24PQ1B	24PQ1P	1.50	2.750	3.750	0.531	1.70	1/2-13	1/2-13 x 2.50	3.0
32PQ1B	32PQ1P	2.00	3.250	4.000	0.531	1.70	1/2-13	1/2-13 x 2.50	3.0
40PQ1B	40PQ1P	2.50	4.000	4.500	0.531	1.95	1/2-13	1/2-13 x 2.75	2.5
48PQ1B	48PQ1P	3.00	4.500	5.310	0.656	2.20	5/8-11	5/8-11 x 3.00	2.0
CODE 62 BLOCK FLANGE OR PAD PLUG									
8PQ2B	8PQ2P	0.50	1.750	2.220	0.344	0.94	5/16-18	5/16-18 x 1.50	6.0
12PQ2B	12PQ2P	0.75	2.000	2.810	0.406	1.19	3/8-16	3/8-16 x 2.00	6.0
16PQ2B	16PQ2P	1.00	2.250	3.190	0.492	1.44	7/16-14	7/16-14 x 2.25	6.0
20PQ2B	20PQ2P	1.25	2.750	3.750	0.531	1.44	1/2-13	1/2-13 x 2.50	6.0
24PQ2B	24PQ2P	1.50	3.250	4.500	0.656	1.69	5/8-11	5/8-11 x 2.75	6.0
32PQ2B	32PQ2P	2.00	4.000	5.250	0.781	1.69	3/4-10	3/4-10 x 3.00	6.0
40PQ2B	40PQ2P	2.50	5.000	6.880	0.906	1.94	7/8-9	7/8-9 x 3.50	6.0
48PQ2B	48PQ2P	3.00	6.000	8.500	1.190	2.44	1 1/8-7	1 1/8-7 x 3.75	6.0

To receive mounting hardware with flange, insert a “K” after the material designator. Mounting hardware kits are available for O-ring Face part numbers and include 4 bolts, 4 lock washers and an O-ring.

Dimensions and pressures for reference only, subject to change.



XHQ40

Dual Seal Flange Connector
Dual Seal / 37° Flare

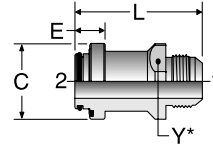

TUBE FITTING PART #	END SIZE		C (in.)	D1 DRILL (in.)	D2 DRILL (in.)	E (in.)	L (in.)	Y (in.)	Dynamic Pressure (x 1,000 PSI)
	1 (in.)	2 DUAL SEAL							SS
8 XHQ40	1/2	1/2	1.25	0.391	0.391	0.69	2.98	1.00	7.2
16 XHQ40	1	1	1.88	0.844	0.844	0.75	3.18	1.63	4.8
24 XHQ40	1 1/2	1 1/2	2.50	1.310	1.310	1.00	4.00	2.13	3.6

LOHQ40

Dual Seal Flange Connector
Dual Seal / ORFS

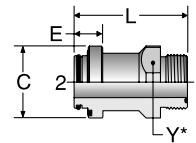

TUBE FITTING PART #	END SIZE		C (in.)	D1 DRILL (in.)	D2 DRILL (in.)	E (in.)	L (in.)	Y (in.)	Dynamic Pressure (x 1,000 PSI)
	1 (in.)	2 DUAL SEAL							SS
8 LOHQ40	1/2	1/2	1.25	0.374	0.374	0.69	2.83	1.00	7.5
16 LOHQ40	1	1	1.88	0.807	0.807	0.75	2.96	1.63	6.0
24 LOHQ40	1 1/2	1 1/2	2.50	1.260	1.260	1.00	3.61	2.13	5.0

FHQ40

Dual Seal Flange Connector
Dual Seal / Male NPTF

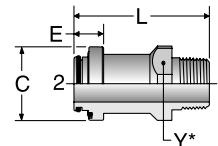

TUBE FITTING PART #	END SIZE		C (in.)	D1 DRILL (in.)	D2 DRILL (in.)	E (in.)	L (in.)	Y (in.)	Dynamic Pressure (x 1,000 PSI)
	1 (in.)	2 DUAL SEAL							SS
8 FHQ40	1/2	1/2	1.25	0.500	0.500	0.69	3.18	1.00	7.2
16 FHQ40	1	1	1.88	0.938	0.938	0.75	3.45	1.63	5.4
24 FHQ40	1 1/2	1 1/2	2.50	1.312	1.312	1.00	4.10	2.13	3.6

Dimensions and pressures for reference only, subject to change.

GHQ40

Dual Seal Flange Connector
Dual Seal / Female NPTF

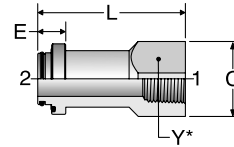

TUBE FITTING PART #	END SIZE		C (in.)	D1 DRILL (in.)	D2 DRILL (in.)	E (in.)	L (in.)	Y (in.)	Dynamic Pressure (x 1,000 PSI)
	1 (in.)	2 DUAL SEAL							SS
8 GHQ40	1/2	1/2	1.25	0.500	0.500	0.69	2.96	1.00	6.0
16 GHQ40	1	1	1.88	0.938	0.938	0.75	3.94	1.63	3.6
24 GHQ40	1 1/2	1 1/2	2.50	1.312	1.312	1.00	4.81	2.25	3.0

F5OHQ40

Dual Seal Flange Connector
Dual Seal / Male SAE-ORB

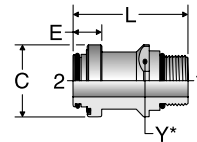

TUBE FITTING PART #	END SIZE		C (in.)	D1 DRILL (in.)	D2 DRILL (in.)	E (in.)	L (in.)	Y (in.)	Dynamic Pressure (x 1,000 PSI)
	1 (in.)	2 DUAL SEAL							SS
8 F5OHQ40	1/2	1/2	1.25	0.394	0.394	0.69	2.87	1.00	6.0
16 F5OHQ40	1	1	1.88	0.844	0.844	0.75	3.00	1.63	4.0
24 F5OHQ40	1 1/2	1 1/2	2.50	1.312	1.312	1.00	3.65	2.17	3.0

G5HQ40

Dual Seal Flange Connector
Dual Seal / Female SAE-ORB

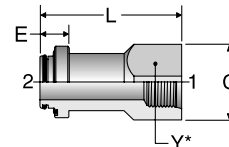

TUBE FITTING PART #	END SIZE		C (in.)	D1 DRILL (in.)	D2 DRILL (in.)	E (in.)	L (in.)	Y (in.)	Dynamic Pressure (x 1,000 PSI)
	1 (in.)	2 DUAL SEAL							SS
8 G5HQ40	1/2	1/2	1.25	0.406	0.406	0.69	2.77	1.00	5.0
16 G5HQ40	1	1	1.88	0.938	0.938	0.75	3.72	1.63	3.5
24 G5HQ40	1 1/2	1 1/2	2.50	1.312	1.312	1.00	4.59	2.25	2.5

Dimensions and pressures for reference only, subject to change.

W7HQ40

Dual Seal Flange Connector
Dual Seal / Socket Weld Pipe

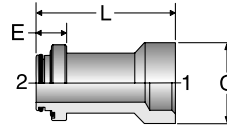

TUBE FITTING PART #	END SIZE		C (in.)	D1 DRILL (in.)	D2 DRILL (in.)	E (in.)	L (in.)	Dynamic Pressure (x 1,000 PSI)
	1 PIPE	2 DUAL SEAL						SS
	8 W7HQ40	1/2						1/2
16 W7HQ40	1	1	1.88	0.938	0.938	0.75	3.44	7.5
24 W7HQ40	1 1/2	1 1/2	2.50	1.312	1.312	1.00	4.43	7.5

PQ40

Dual Seal Flange Connector
Dual Seal Plug

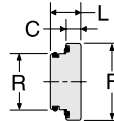

TUBE FITTING PART #	END SIZE		F (in.)	C (in.)	L (in.)	R (in.)	Dynamic Pressure (x 1,000 PSI)
	2 DUAL SEAL	SS					
	8 PQ40	1/2					1.25
16 PQ40	1	1.88	0.38	0.75	1.21	7.5	
24 PQ40	1 1/2	2.50	0.50	1.00	1.75	7.5	

Q4 Insert

Dual Seal Flange Insert



TUBE FITTING PART #	END SIZE		L (in.)	C (in.)	Dynamic Pressure (x 1,000 PSI)
	2 DUAL SEAL	SS			
	8 Q4 INSERT	1/2			1.00
16 Q4 INSERT	1	1.00	1.37	7.5	
24 Q4 INSERT	1 1/2	1.00	1.74	7.5	

Dimensions and pressures for reference only, subject to change.

